

Pioneer

CD PLAYER

DEX-P99RS

Operation Manual

English

Thank you for purchasing this PIONEER product.

Please read through this manual before using the product for the first time, to ensure proper use. *After reading, please keep the manual in a safe and accessible place for future reference.*

01 Before You Start

- Information for users on collection and disposal of old equipment and used batteries **5**
- About this unit **5**
- Features **6**
- Visit our website **6**
- In case of trouble **6**
- Protecting your unit from theft **6**
 - Removing the front panel **6**
 - Attaching the front panel **7**
- Resetting the microprocessor **7**
- Reverse mode **7**
- Use and care of the remote control **7**
 - Installing and removing the battery **7**
 - Using the remote control **8**

02 Operating this unit

- What's what **9**
 - Head unit **9**
 - Steering remote control **9**
- Basic Operations **10**
 - Power ON/OFF **10**
 - Selecting a source **10**
 - Loading a disc **11**
 - Adjusting the volume **11**
- Tuner **12**
 - Basic Operations **12**
 - Storing and recalling broadcast frequencies **13**
 - Receiving PTY alarm broadcasts **13**
 - Introduction to advanced operations **13**
 - Storing the strongest broadcast frequencies **13**
 - Tuning in strong signals **13**
 - Selecting alternative frequencies **14**
 - Receiving traffic announcements **15**
 - Using PTY functions **15**
 - Using radio text **16**
 - PTY list **16**

Built-in CD Player **17**

- Basic Operations **17**
- Displaying text information on disc **18**
- Selecting tracks from the track title list **18**
- Selecting files from the file name list **19**
- Introduction to advanced operations **19**
- Selecting a repeat play range **19**
- Playing tracks in random order **19**
- Scanning folders and tracks **20**
- Pausing playback **20**
- Using disc title functions **20**

Playing songs in a USB storage device **21**

- Basic Operations **21**
- Displaying text information of an audio file **21**
- Selecting files from the file name list **21**
- Introduction to advanced operations **22**

Playing songs on iPod **23**

- Basic Operations **23**
- Browsing for a song **23**
- Displaying text information on iPod **24**
- Introduction to advanced operations **24**
- Playing songs in a random order (shuffle) **25**
- Playing all songs in a random order (shuffle all) **25**
- Playing songs related to the currently playing song **25**
- Operating this unit's iPod function from your iPod **25**
- Changing audiobook speed **26**

03 Audio Adjustments

- Operation modes **27**
 - Adjusting the audio easily **27**

- Adjusting the audio finely **27**
- Extra functions **27**
- Introduction of audio adjustments **27**
- Switching left and right channel **28**
- Using balance adjustment **28**
- Using the position selector **28**
- About the network function **28**
 - Adjustable parameters **29**
 - Points concerning network adjustments **29**
 - Muting the speaker unit (filter) **30**
 - Adjusting network **30**
- Using the time alignment **31**
 - Adjusting the time alignment **32**
- Recalling or copying equalizer curves **32**
 - Recalling the equalizer curve **32**
 - Copying the equalizer curve **33**
- Fine-adjusting equalizer curve **33**
- Using the auto-equalizer **33**
- Using the sound retriever **34**
- Adjusting loudness **34**
- Adjusting source levels **34**
- Auto TA and EQ (auto-time alignment and auto-equalizing) **34**
 - Before operating the auto TA and EQ function **35**
 - Carrying out auto TA and EQ **36**

04 Initial Settings

- Adjusting initial settings **38**
- Selecting the display language **38**
- Setting the speakers **38**
- Setting the clock **39**
- Turning the off clock display on or off **39**
- Setting the FM tuning step **39**
- Switching Auto PI Seek **39**
- Switching the warning tone **40**
- Switching the face auto open **40**
- Switching the auxiliary setting **40**
- Switching the dimmer setting **40**
- Adjusting the brightness **40**
- Selecting the illumination color **40**

- Adjusting the illumination color **41**
- Setting the illumination interlock **41**
- Correcting distorted sound **41**
- Resetting the audio functions **41**
- Switching the sound muting/attenuation **42**
- Setting the polarity of the door operation **42**
- Setting the door mute setting **42**
- Switching the reverse mode **42**
- Switching the ever scroll **43**
- Activating the BT Audio source **43**
- Entering PIN code for Bluetooth wireless connection **43**
- Displaying system version for repair **43**

05 Other Functions

- Using the AUX source **45**
 - About AUX1 and AUX2 **45**
 - AUX1 source: **45**
 - AUX2 source: **45**
 - Selecting AUX as the source **45**
 - Setting the AUX title **45**
- Using the external unit **45**
 - Selecting the external unit as the source **45**
 - Basic operation **46**
 - Advanced operations **46**
- Using different entertainment displays **46**
- Using the DF (direct function) button **46**

06 Available accessories

- Playing songs on iPod **47**
 - Basic operation **47**
 - Displaying text information on iPod **47**
 - Browsing for a song **47**
 - Introduction to advanced operations **47**
- Bluetooth Audio **48**
 - Basic Operations **48**
 - Function and operation **49**
 - Connecting a Bluetooth audio player **49**

- Playing songs on a Bluetooth audio player **50**
 - Stopping playback **50**
 - Disconnecting a Bluetooth audio player **50**
 - Displaying BD (Bluetooth Device) address **50**
 - Bluetooth Telephone **50**
 - Basic Operations **50**
 - Setting up for hands-free phoning **51**
 - Making a phone call **51**
 - Taking a phone call **52**
 - Function and operation **52**
 - Connecting a cellular phone **53**
 - Disconnecting a cellular phone **53**
 - Registering a connected cellular phone **53**
 - Deleting a registered phone **54**
 - Connecting to a registered cellular phone **54**
 - Using the phone book **54**
 - Using the call history **57**
 - Making a call by entering phone number **57**
 - Clearing memory **58**
 - Setting automatic rejecting **58**
 - Setting automatic answering **58**
 - Switching the ring tone **58**
 - Echo canceling and noise reduction **59**
 - Multi-CD Player **59**
 - Basic Operations **59**
 - Using CD TEXT functions **59**
 - Introduction to advanced operations **59**
 - Using compression and bass emphasis **60**
 - Using ITS playlists **60**
 - Using disc title functions **62**
 - DVD Player **62**
 - Basic Operations **62**
 - Introduction to advanced operations **63**
 - TV tuner **64**
 - Basic Operations **64**
 - Storing and recalling broadcast stations **64**
 - Storing the strongest broadcast stations sequentially **65**
- **Additional Information**
- Error messages **66**
 - Understanding auto TA and EQ error messages **67**
 - Handling guideline of discs and player **68**
 - DualDiscs **68**
 - Handling guideline of USB storage device and this unit **68**
 - Compressed audio compatibility (disc, USB) **69**
 - Supplemental information of compressed audio (disc, USB) **69**
 - Compressed audio files on the disc **69**
 - Compressed audio files in the USB storage device **70**
 - Example of a hierarchy and playback sequences **70**
 - The sequence of audio files on the disc **70**
 - The sequence of audio files on the USB storage device **70**
 - iPod **70**
 - iPod compatibility **70**
 - About handling the iPod **71**
 - About iPod settings **71**
 - Copyright and trademark notice **71**
 - Specifications **73**

Before You Start

Information for users on collection and disposal of old equipment and used batteries

(Symbol for equipment)



(Symbol examples for batteries)



Pb

These symbols on the products, packaging, and/or accompanying documents mean that used electrical and electronic products and batteries should not be mixed with general household waste. For proper treatment, recovery and recycling of old products and used batteries, please take them to applicable collection points in accordance with your national legislation.

By disposing of these products and batteries correctly, you will help to save valuable resources and prevent any potential negative effects on human health and the environment which could otherwise arise from inappropriate waste handling.

For more information about collection and recycling of old products and batteries, please contact your local municipality, your waste disposal service or the point of sale where you purchased the items.

These symbols are only valid in the European Union.

For countries outside the European Union:

If you wish to discard these items, please contact your local authorities or dealer and ask for the correct method of disposal. 

About this unit

The tuner frequencies on this unit are allocated for use in Western Europe, Asia, the Middle East, Africa and Oceania. Use in other areas may result in poor reception. The RDS (radio data system) function operates only in areas with FM stations broadcasting RDS signals.

CAUTION

- Do not allow this unit to come into contact with liquids. Electrical shock could result. Also, damage to this unit, smoke, and overheating could result from contact with liquids.
- "CLASS 1 LASER PRODUCT"
This product contains a laser diode of higher class than 1. To ensure continued safety, do not remove any covers or attempt to gain access to the inside of the product. Refer all servicing to qualified personnel.
- The Pioneer CarStereo-Pass is for use only in Germany.
- Keep this manual handy as a reference for operating procedures and precautions.
- Always keep the volume low enough so that you can hear sounds from outside the vehicle.
- Protect this unit from moisture.
- If the battery is disconnected or discharged, the preset memory will be erased and must be reprogrammed.

Important

The red lead (ACC) of this unit should be connected to a terminal coupled with ignition switch on/off operations. If this is not done, the vehicle battery may be drained. 

Features

This unit is compatible with a wide variety of file formats and media/storage devices.

File format compatibility

- WMA
- MP3
- AAC
- WAV

For details about compatibility, refer to *Additional Information* on page 66.

Media/storage device compatibility

- CD/CD-R/CD-RW
 - USB portable audio player/USB memory
- Make inquiries to the manufacturer about your USB portable audio player/USB memory. For details about compatibility, refer to *Additional Information* on page 66.

iPod compatibility

This unit can control and listen to songs on an iPod.

In this manual, iPod and iPhone will be referred to as iPod.

For details about the supported iPod, refer to *iPod compatibility* on page 70.

CAUTION

- Pioneer accepts no responsibility for data lost on the USB memory/USB portable audio player even if that data is lost while using this unit.
- Pioneer accepts no responsibility for data lost on the iPod even if that data is lost while using this unit. 

Visit our website

Visit us at the following site:

<http://www.pioneer.co.uk>

- Register your product. We will keep the details of your purchase on file to help you refer to this information in the event of an insurance claim such as loss or theft.
- We offer the latest information about Pioneer Corporation on our website. 

In case of trouble

Should this product fail to operate properly, please contact your dealer or nearest authorized Pioneer Service Station. 

Protecting your unit from theft

The front panel can be detached to deter theft.

- If the front panel is not detached from the head unit within five seconds of turning off the ignition, a warning tone sounds.
- You can turn off the warning tone. Refer to *Switching the warning tone* on page 40.

Important

- Handle gently when removing or attaching the front panel.
- Avoid subjecting the front panel to excessive shock.
- Keep the front panel out of direct sunlight and high temperatures.

Removing the front panel

1 Press /Open to open the front panel.

If a disc has been inserted to this unit, pressing and holding /Open enable to open the front panel without ejecting a disc.

Before You Start

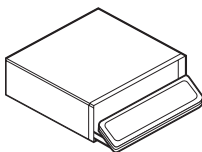

2 Press the release button, slide and remove the front panel toward you.

Take care not to grip it too tightly or to drop the front panel and protect it from contact with water or other fluids to prevent permanent damage.

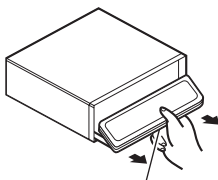

Release button

3 Put the front panel into the provided protective case for safe keeping.

Attaching the front panel

1 Make sure the inner cover is closed.

2 Replace the front panel by clipping it into place.

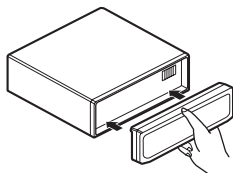

Resetting the microprocessor

The microprocessor must be reset under the following conditions:

- Prior to using this unit for the first time after installation
- If the unit fails to operate properly

- When strange or incorrect messages appear on the display
- **Press RESET with a pen tip or other pointed instrument.**

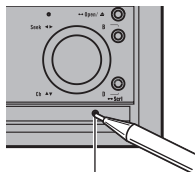

RESET button



Reverse mode

If you do not perform an operation within about 30 seconds, screen indications start to reverse, and then continue reversing every 10 seconds. Pressing button **B** when power to this unit is turned off while the ignition switch is set to ACC or ON cancels the reverse mode. Press button **B** again to start the reverse mode. □

Use and care of the remote control

Installing and removing the battery

Slide the tray on the back of the remote control out and insert the battery with the plus (+) and minus (-) poles aligned properly.

- When using for the first time, pull out the film protruding from the tray.

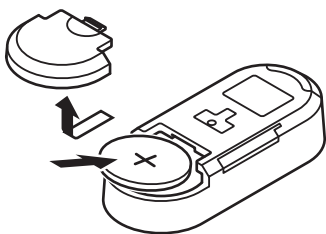

⚠ WARNING

- Keep the battery out of the reach of children. Should the battery be swallowed, consult a doctor immediately.
- Batteries (battery pack or batteries installed) shall not be exposed to excessive heat such as sunshine, fire or the like.

⚠ CAUTION

- Use one **CR2032 (3 V)** lithium battery.
- Remove the battery if the remote control is not used for a month or longer.
- There is a danger of explosion if the battery is incorrectly replaced. Replace only with the same or equivalent type.
- Do not handle the battery with metallic tools.
- Do not store the battery with metallic objects.
- If the battery leaks, wipe the remote control completely clean and install a new battery.
- When disposing of used batteries, comply with governmental regulations or environmental public institutions' rules that apply in your country/area.

Using the remote control

The remote control may not function properly in direct sunlight.

👉 Important

- Do not store the remote control in high temperatures or direct sunlight.
- Do not let the remote control fall onto the floor, where it may become jammed under the brake or accelerator pedal.

- If any of the following problems occur, immediately stop using the unit and consult the dealer from whom you purchased it.
 - Smoke is coming from the unit.
 - Abnormal odor is coming from the unit.
 - A foreign object has entered the unit.
 - Liquid has been spilled on or into the unit.
 If you continue to use this unit without finding a remedy, the unit may be damaged badly, resulting in a serious accident or fire.
- Do not disassemble or modify this unit. To do so may cause a malfunction.
- Do not operate this unit while manipulating the steering wheel as it might result in a traffic accident.
- If you need to operate this unit while driving, look ahead carefully to avoid being involved in a traffic accident.
- Do not leave this steering remote control free (unattached). When stopping the car or turning, the unit might drop on the floor. If the unit rolls under the brake pedal, it might prevent the driver from braking properly, causing serious problems. Be sure to fix the steering remote control to the steering wheel.

Operating this unit

What's what

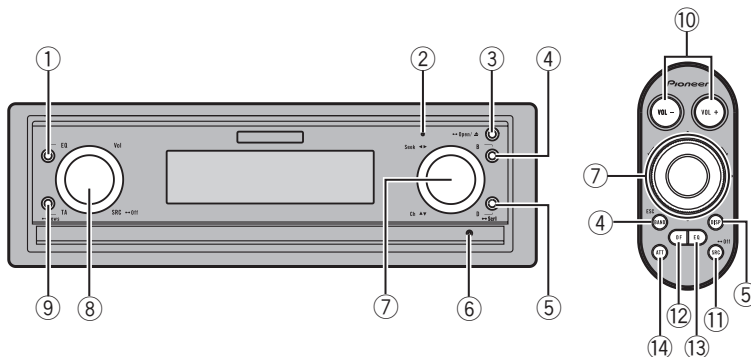

Head unit

- ① **EQ button**
Press to select various equalizer curves.
Press and hold to turn the display indication and button illumination off or on.
- ② **Display off indicator**
Lights up when the display is turned off.
- ③ **▲/Open button**
Press to eject a disc from this unit.
Press and hold to open or close the front panel.
- ④ **B button**
Press to select among three FM bands and MW/LW bands.
Press to return to the ordinary display when operating the menu.
- ⑤ **D/Scrl button**
Press to select different displays.
Press and hold to scroll through the text information.
- ⑥ **RESET button**
Press to reset the microprocessor.
- ⑦ **MULTI-CONTROL**
Move to perform manual seek tuning, fast forward, reverse and track search controls. Also used for controlling functions. Turn to display the disc title list, track title list, folder list, file list or preset channel list depending on the source.
- ⑧ **SRC/Off button, Vol**
This unit is turned on by selecting a source. Press to cycle through all the available sources.
Rotate it to increase or decrease the volume.
- ⑨ **TA/News button**
Press to turn TA function on or off. Press and hold to turn NEWS function on or off.

Steering remote control

Operation is the same as when using the buttons on the head unit.

- ⑩ **VOL -/VOL + buttons**
Press to increase or decrease the volume.
- ⑪ **SRC/Off button**
This unit is turned on by selecting a source. Press to cycle through all the available sources.

Operating this unit

⑫ EQ button

Press to select various equalizer curves.

⑬ DF button

Press to operate the preprogrammed functions for each source. (Refer to *Using the DF (direct function) button* on page 46.)

⑭ ATT button

Press to quickly lower the volume level by about 90%. Press once more to return to the original volume level. 

Basic Operations

Power ON/OFF

Turning the unit on

- Press **SRC/Off** to turn the unit on.

Turning the unit off

- Press **SRC/Off** and hold until the unit turns off.

Selecting a source

You can select a source you want to listen to.

- Press **SRC/Off** repeatedly to switch between the following sources.

Tuner (tuner)—**TV** (television)—**DVD** (DVD player/multi-DVD player)—**CD** (built-in CD player)—**Multi CD** (multi-CD player)—**iPod** (iPod connected with the interface adapter)—**USB** (USB storage device)—**iPod** (iPod connected using USB input)—**EXT** (external unit 1)—**EXT** (external unit 2)—**AUX1** (AUX1)—**AUX2** (AUX2)—**BT Audio** (BT audio)—**TEL** (BT telephone)



Notes

- In the following cases, the sound source will not change.
 - When no unit corresponding to the selected source is connected.
 - When there is no disc or magazine in the player.
 - When the iPod is not connected to this unit with the interface adapter.
 - When AUX (auxiliary input) is set to off (refer to page 40).
 - When the **BT Audio** source is set to off (refer to *Activating the BT Audio source* on page 43).
- When an USB storage device or iPod is not connected to the USB port of this unit, **NO DEVICE** is displayed.

Operating this unit

- AUX1 is set to on by default. Turn off the AUX1 when not in use (refer to *Switching the auxiliary setting* on page 40).
- Charging the portable audio player using car's DC power source while connecting it to AUX input may generate noise. In this case, stop charging.
- External unit refers to a Pioneer product (such as ones available in the future) that, although incompatible as a source, enables control of basic functions with this unit. Two external units can be controlled with this unit. When two external units are connected, the external unit is automatically allocated to external unit 1 or external unit 2 by this unit.
- When this unit's blue/white lead is connected to the vehicle's auto-antenna relay control terminal, the vehicle's antenna extends when this unit's source is turned on. To retract the antenna, turn the source off.
- Certain devices may need to be switched on before being connected to this unit.

Loading a disc

1 Press **▲/Open** to open the front panel.

CD loading slot appears.

2 Insert a CD into the CD loading slot.

Front panel is closed automatically, and playback will start.

- **When loading a CD/CD-R/CD-RW, face the label side of a disc up.**

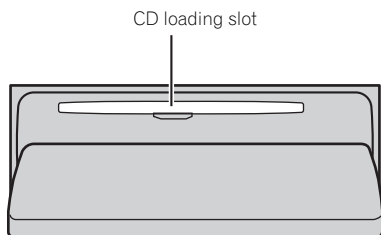

- You can eject a disc by pressing **▲/Open**.
- After a CD has been inserted, press **SRC/Off** to select the built-in CD player.

Notes

- The built-in CD player plays one, standard, 12-cm CD (-R/-RW) at a time. Playing back an 8-cm disc is not possible with this unit.
- The built-in CD player can play back audio CD and compressed audio recorded on a CD-ROM. (Please see the following section for files that can be played back. Refer to page 69.)
- Read the precautions for the player and discs in the following section. Refer to page 68.
- Do not insert anything other than a CD into the CD loading slot.
- There is sometimes a delay between starting up disc playback and the sound being issued. When being read, **FORMAT READ** is displayed.
- If you cannot insert a disc completely or if after you insert a disc the disc does not play, check that the label side of the disc is up. Press **▲/Open** to eject the disc, and check the disc for damage before inserting it again.
- When the disc loading or ejecting function does not operate properly, you can eject the disc by pressing and holding **▲/Open** while opening the front panel.
- If an error message is displayed, refer to *Error messages* on page 66.

Adjusting the volume

- **Use Vol to adjust the sound level.**
 - With the remote control, press **VOL +/VOL -** to adjust the volume. 

Tuner

Basic Operations

RDS

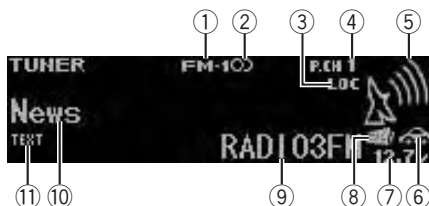

- ① Band indicator
- ② (stereo) indicator
Appears when the selected frequency is being broadcast in stereo.
- ③ **LOC** indicator
Appears when local seek tuning is on.
- ④ Preset number indicator
- ⑤ Signal level indicator
Shows the radio wave strength.
- ⑥ TP indicator
Appears when a TP station is tuned in.
- ⑦ Voltage indicator
Shows the battery voltage.
 - The level displayed on the voltage indicator may differ from the actual voltage level.
- ⑧ News indicator
Appears when the set news program is received.
- ⑨ Program service name
- ⑩ PTY label indicator
- ⑪ **TEXT** indicator
Shows when the radio text is received.

Non-RDS or MW/LW

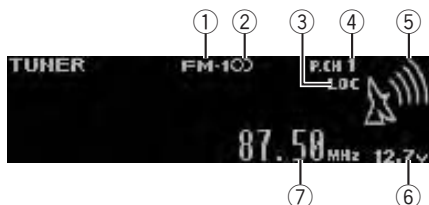

- ① Band indicator

- ② (stereo) indicator
Appears when the selected frequency is being broadcast in stereo.
- ③ **LOC** indicator
Appears when local seek tuning is on.
- ④ Preset number indicator
- ⑤ Signal level indicator
Shows the radio wave strength.
- ⑥ Voltage indicator
Shows the battery voltage.
 - The level displayed on the voltage indicator may differ from the actual voltage level.
- ⑦ Frequency indicator

● Select a band

Press **B**.

- Band can be selected from among **FM1**, **FM2**, **FM3** or **MW/LW**.

● Manual tuning (step by step)

Push **MULTI-CONTROL** left or right.

● Seek tuning

Push and hold **MULTI-CONTROL** left or right, and then release.

- You can cancel seek tuning by pushing **MULTI-CONTROL** left or right.
- While pushing and holding **MULTI-CONTROL** left or right, you can skip stations. Seek tuning starts as soon as you release **MULTI-CONTROL**.

Notes

- This unit's AF (alternative frequencies search) function can be turned on and off. AF should be off for normal tuning operation (refer to page 14).
- RDS service may not be provided by all stations.
- RDS functions such as AF and TA are only active when your radio is tuned to an RDS station.

Operating this unit

Storing and recalling broadcast frequencies

You can easily store up to six broadcast frequencies for later recall.

- Six stations for each band can be stored in memory.

1 Use MULTI-CONTROL to store the selected frequency in memory.

Turn to change the preset number. Press and hold to store.

2 Use MULTI-CONTROL to select the desired station.

Turn to change the station. Press to select.

- All stations stored for FM bands can be recalled from each independent FM band.
- You can also change the station by pushing **MULTI-CONTROL** up or down.
- To return to the ordinary display, press **B**.
- If you do not operate the list within about 30 seconds, the display automatically returns to the ordinary display.
- You can also recall radio station frequencies assigned to preset tuning numbers by pushing **MULTI-CONTROL** up or down during the frequency display.

Receiving PTY alarm broadcasts

When the emergency PTY code broadcasts, the unit receives it automatically (**ALARM** appears). When the broadcasting ends, the system returns to the previous source.

- An emergency announcement can be canceled by pressing **TA/News**, **SRC/Off**, **B** or **MULTI-CONTROL**.

Introduction to advanced operations

1 Press MULTI-CONTROL to display the main menu.

2 Use MULTI-CONTROL to select FUNCTION.

Turn to change the menu option. Press to select.

3 Turn MULTI-CONTROL to select the function.

BSM (best stations memory)—**Regional** (regional)—**Local** (local seek tuning)—

PTY search (program type selection)—

Traffic Announce (traffic announcement standby)—**Alternative FREQ** (alternative frequencies search)—**News interrupt** (news program interruption)



Notes

- To return to the ordinary display, press **B**.
- If you do not operate functions within about 30 seconds, the display automatically returns to the ordinary display.
- If MW/LW band is selected, you can only select **BSM** or **Local**.

Storing the strongest broadcast frequencies

BSM (best stations memory) lets you automatically store the six strongest broadcast frequencies.

1 Use MULTI-CONTROL to select BSM in the function menu.

Refer to *Introduction to advanced operations* on this page.

2 Press MULTI-CONTROL to turn BSM on.

The six strongest broadcast frequencies are stored in the order of their signal strength.

- To cancel, press **MULTI-CONTROL** again.

Tuning in strong signals

Local seek tuning lets you tune in only those radio stations with sufficiently strong signals for good reception.

Operating this unit

1 Use MULTI-CONTROL to select Local in the function menu.

Local appears in the display.

2 Press MULTI-CONTROL to turn local seek tuning on.

- To turn local seek tuning off, press

MULTI-CONTROL again.

3 Push MULTI-CONTROL left or right to select the desired setting.

FM: **Level 1—Level 2—Level 3—Level 4**
 MW/LW: **Level 1—Level 2**

Larger setting number is higher level. The highest level setting allows reception of only the strongest stations, while lower settings let you receive progressively weaker stations.

Selecting alternative frequencies

When the tuner cannot get a good reception, the unit automatically searches for a different station in the same network.

1 Use MULTI-CONTROL to select Alternative FREQ in the function menu.

Refer to *Introduction to advanced operations* on the previous page.

2 Press MULTI-CONTROL to turn AF on.

- To turn off, press **MULTI-CONTROL** again.

Notes

- Only RDS stations are tuned in during seek tuning or BSM when AF is on.
- When you recall a preset station, the tuner may update the preset station with a new frequency from the station's AF list. No preset number appears on the display if the RDS data for the station received differs from that of the originally stored station.
- During AF search, sound may be temporarily interrupted.
- AF can be turned on or off independently for each FM band.

Using PI Seek

If the tuner cannot find a suitable station, or reception status becomes bad, the unit automatically searches for a different station with the same programming. During the search, **PI SEEK** is displayed and the output is muted.

Using Auto PI Seek for preset stations

When preset stations cannot be recalled, the unit can be set to perform PI Seek during pre-set recall.

- The default setting for Auto PI Seek is off. Refer to *Switching Auto PI Seek* on page 39.

Limiting stations to regional programming

When AF is used, the regional function limits the selection of stations broadcasting regional programs.

1 Use MULTI-CONTROL to select Regional in the function menu.

Refer to *Introduction to advanced operations* on the previous page.

2 Press MULTI-CONTROL to turn the regional function on.

- To turn off, press **MULTI-CONTROL** again.

Notes

- Regional programming and regional networks are organized differently depending on the country (i.e., they may change according to the hour, state or broadcast area).
- The preset number may disappear from the display if the tuner tunes in a regional station which differs from the originally set station.
- The regional function can be turned on or off independently for each FM band.

Operating this unit

Receiving traffic announcements

TA (traffic announcement standby) lets you receive traffic announcements automatically, no matter what source you are listening to. TA can be activated for both a TP station (a station that broadcasts traffic information) or an enhanced other network's TP station (a station carrying information which cross-references TP stations).

1 Tune in a TP or enhanced other network's TP station.

The TP () indicator will light.

2 Press TA/News to turn traffic announcement standby on.

- To turn off, press **TA/News** again.

3 Use Vol to adjust the TA volume when a traffic announcement begins.

The newly set volume is stored in memory and recalled for subsequent traffic announcements.

4 Press TA/News while a traffic announcement is being received to cancel the announcement.

The tuner returns to the original source but remains in the standby mode until **TA/News** is pressed again.

- You can also cancel the announcement by pressing **SRC/Off, B** or **MULTI-CONTROL** while a traffic announcement is being received.

Notes

- You can also turn this function on or off in the menu that appears by using **MULTI-CONTROL**.
- The system switches back to the original source following traffic announcement reception.
- Only TP and enhanced other network's TP stations are tuned in during seek tuning or BSM when TA is on.

Using PTY functions

You can tune in a station by using PTY (program type) information.

Searching for an RDS station by PTY information

You can search for general types of broadcasting programs, such as those listed in the following section. Refer to the next page.

1 Use MULTI-CONTROL to select PTY search in the function menu.

Refer to *Introduction to advanced operations* on page 13.

2 Push MULTI-CONTROL left or right to select a program type. News&Inf—Popular—Classics—Others

3 Press MULTI-CONTROL to begin the search.

The unit searches for a station broadcasting that program type. When a station is found, its program service name is displayed.

PTY (program type ID code) information is listed in the following section. Refer to the next page.

- To cancel the search, press **MULTI-CONTROL** again.
- The program of some stations may differ from that indicated by the transmitted PTY.
- If no station is broadcasting the type of program you searched for, **Not found** is displayed for about two seconds and then the tuner returns to the original station.

Using news program interruption

When a news program is broadcast from a PTY code news station, the unit automatically switches to the news broadcast station. When the news program ends, reception of the previous program resumes.

Operating this unit

● Press **TA/News** and hold to turn on news program interruption.

Press **TA/News** until **ON** appears in the display.

- To turn off news program interruption, press **TA/News** and hold until **OFF** appears in the display.
- A news program can be canceled by pressing **TA/News**, **SRC/Off**, **B** or **MULTI-CONTROL**.



Note

You can also turn on or off news programs in the menu that appears by using **MULTI-CONTROL**.

Using radio text

This tuner can display radio text data transmitted by RDS stations, such as station information, the name of the currently broadcast song and the name of the artist.

- The tuner automatically memorizes the three latest radio text broadcasts received, replacing text from the least recent reception with new text when it is received.

Displaying radio text

You can display the currently received radio text and the three most recent radio texts.

1 Press **D/Scrl** and hold to display radio text.

Radio text for the currently broadcasting station is displayed.

- You can cancel radio text display by pressing **D/Scrl**, **TA/News**, **SRC/Off**, **EQ** or **B**.
- When no radio text is received, **NO TEXT** appears in the display.

2 Push **MULTI-CONTROL** left or right to recall the three most recent radio texts.

Pushing **MULTI-CONTROL** left or right switches between the current and the three radio text data displays.

- If there is no radio text data in memory the display will not change.

3 Push **MULTI-CONTROL** up or down to scroll.

Push **MULTI-CONTROL** up to go to the beginning. Push **MULTI-CONTROL** down to scroll the radio text data.

Storing and recalling radio text

You can store data from up to six radio text transmissions for keys **RT Memo 1** to **RT Memo 6**.

1 Display the radio text you want to store in memory.

Refer to *Displaying radio text* on this page.

2 Use **MULTI-CONTROL** to store the selected radio text.

Turn to change the preset number. Press and hold to store.

3 Use **MULTI-CONTROL** to select the desired radio text.

Turn to change the radio text. Press to select.

- To return to the ordinary display, press **B**.
- If you do not operate the list within about 30 seconds, the display automatically returns to the ordinary display.

PTY list

General	Specific	Type of program
News&Inf	NEWS	News
	AFFAIRS	Current affairs
	INFO	General information and advice
	SPORT	Sports
	WEATHER	Weather reports/meteorological information
FINANCE	Stock market reports, commerce, trading, etc.	

Operating this unit

Popular	POP MUS	Popular music
	ROCK MUS	Contemporary modern music
	EASY MUS	Easy listening music
	OTH MUS	Non-categorized music
	JAZZ	Jazz
	COUNTRY	Country music
	NAT MUS	National music
	OLDIES	Oldies, golden oldies
	FOLK MUS	Folk music
Classics	L. CLASS	Light classical music
	CLASSIC	Classical music
Others	EDUCATE	Educational programs
	DRAMA	Radio plays and serials
	CULTURE	National or regional culture
	SCIENCE	Nature, science and technology
	VARIED	Light entertainment
	CHILDREN	Children's
	SOCIAL	Social affairs
	RELIGION	Religious affairs or services
	PHONE IN	Phone in
	TOURING	Travel programs; not for traffic announcements
LEISURE	Hobbies and recreational activities	
DOCUMENT	Documentaries	



Built-in CD Player

Basic Operations



- ① **WMA/MP3/AAC/WAV** indicator
Shows the type of audio file currently playing when the compressed audio is playing.
- ② Folder number indicator
Shows the folder number currently playing when the compressed audio is playing.
- ③ Track number indicator
- ④ Voltage indicator
Shows the battery voltage.
 - The level displayed on the voltage indicator may differ from the actual voltage level.
- ⑤ Play time indicator
- ⑥ Bit rate/sampling frequency indicator
Shows the bit rate or sampling frequency of the current track (file) when the compressed audio is playing.
 - When playing back VBR (variable bit rate)-recorded WMA files, the average bit rate value is displayed.
 - When playing back VBR (variable bit rate)-recorded MP3 files, **VBR** is displayed instead of bit rate value.

● Select a folder

Push **MULTI-CONTROL** up or down.

- You cannot select a folder that does not have a compressed audio file recorded in it.

● Select a track

Push **MULTI-CONTROL** left or right.

● Fast forward or reverse

Push and hold **MULTI-CONTROL** left or right.

- When playing compressed audio, there is no sound on fast forward or reverse.

Operating this unit

● Return to root folder

Press and hold **B**.

- If folder 01 (ROOT) contains no files, playback commences with folder 02.

● Switch between compressed audio and CD-DA

Press **B**.

- This operation is available only when playing CD-EXTRA or MIXED-MODE CDs.
- If you have switched between compressed audio and CD-DA, playback starts at the first track on the disc.

Note

Playback is carried out in order of file number. Folders are skipped if they contain no files. (If folder 01 (ROOT) contains no files, playback commences with folder 02.)













Displaying text information on disc

● Press D/ScrI to select the desired text information.













• For title entered CD

Play time—: disc title and play time

• For CD TEXT discs

Play time—: disc artist name and : track title—: disc artist name and : disc title—: disc title and : track title—: track artist name and : track title—: track title and play time—: track title, : track artist name and : disc title

• For WMA/MP3/AAC

Play time—: folder name and : file name—: artist name and : track title—: artist name and : album title—: album title and : track title—: track title and play time—: comment and play time—: track title, : artist name and : album title

• For WAV

Play time—: folder name and : file name

Notes

- You can scroll through text data by pressing and holding **D/ScrI**.
- Audio CD that contains certain information such as text and/or number is CD TEXT.
- If specific information is not recorded on a disc, title or name is not displayed.
- Depending on the version of iTunes used to write MP3 files onto a disc, comment information may not be correctly displayed.
- Depending on the version of Windows Media™ Player used to encode WMA files, album names and other text information may not be correctly displayed.
- The sampling frequency shown in the display may be abbreviated.
- When Ever Scroll is set to ON at the initial setting, text information scrolls continuously in the display. Refer to *Switching the ever scroll* on page 43.
- Depending on the character sets in the disc, Russian texts may be garbled. About the allowed character sets for Russian texts, refer to *Compressed audio files on the disc* on page 69.

Selecting tracks from the track title list

Track title list lets you see the list of track titles on a CD TEXT disc and select one of them to play back.

● Use MULTI-CONTROL to select the desired track title.

Turn to change the track title. Press to play.

- You can scroll through text data by pressing and holding **D/ScrI**.
- To return to the ordinary display, press **B**.
- If you do not operate the list within about 30 seconds, the display automatically returns to the ordinary display.

Operating this unit

Selecting files from the file name list

File name list lets you see the list of file names (or folder names) and select one of them to playback.

● Use MULTI-CONTROL to select the desired file name (or folder name).

Turn to change the name of file or folder.

- when a file is selected, press to play.
- when a folder is selected, press to see a list of files (or folders) in the selected folder.
- when a folder is selected, press and hold to play a song in the selected folder.

■ You can also play the file by pushing MULTI-CONTROL right.

- To return to the previous list (the folder one level higher), push MULTI-CONTROL left.
- Number of the folders/files in the currently selected folder will be indicated on the right side of the display.
- You can scroll through text data by pressing and holding **D/Scrl**.
- To return to the ordinary display, press **B**.
- If you do not operate the list within about 30 seconds, the display automatically returns to the ordinary display.

Introduction to advanced operations

1 Press MULTI-CONTROL to display the main menu.

2 Use MULTI-CONTROL to select FUNCTION.

Turn to change the menu option. Press to select.

3 Turn MULTI-CONTROL to select the function.

Play mode (repeat play)—**Random mode** (random play)—**Scan mode** (scan play)—**Pause** (pause)—**TitleInput "A"** (disc title input)



Notes

- To return to the ordinary display, press **B**.
- If you do not operate functions except for **TitleInput "A"** within about 30 seconds, the display automatically returns to the ordinary display.
- When playing a compressed audio disc or CD TEXT disc, you cannot switch to disc title input display.

Selecting a repeat play range

1 Use MULTI-CONTROL to select Play mode in the function menu.

Refer to *Introduction to advanced operations* on this page.

2 Press MULTI-CONTROL to select your favorite setting.

- **Disc repeat** – Repeat all tracks
- **Track repeat** – Repeat the current track
- **Folder repeat** – Repeat the current folder
- If you select another folder during repeat play, the repeat play range changes to disc repeat.
- Performing track search or fast forward/reverse during **Track repeat** (track repeat) changes the repeat play range to **Disc repeat/ Folder repeat**.
- When **Folder repeat** (folder repeat) is selected, it is not possible to playback a subfolder of that folder.

Playing tracks in random order

Tracks in a selected repeat range are played in random order.

1 Use MULTI-CONTROL to select Random mode in the function menu.

Refer to *Introduction to advanced operations* on this page.

2 Press MULTI-CONTROL to turn random play on.

- Tracks play in a random order.
- To turn random play off, press MULTI-CONTROL again.

Operating this unit

Scanning folders and tracks

Scan play searches the song within the selected repeat range.

1 Use MULTI-CONTROL to select Scan mode in the function menu.

Refer to *Introduction to advanced operations* on the previous page.

2 Press MULTI-CONTROL to turn scan play on.

The first 10 seconds of each track is played.

3 When you find the desired track press MULTI-CONTROL to turn scan play off.

- If the display has automatically returned to the playback display, select **Scan mode** again by using **MULTI-CONTROL**.
- After scanning of a disc (folder) is finished, normal playback of the tracks begins.

Pausing playback

1 Use MULTI-CONTROL to select Pause in the function menu.

Refer to *Introduction to advanced operations* on the previous page.

2 Press MULTI-CONTROL to turn pause on.

Playback of the current track pauses.

- To turn pause off, press **MULTI-CONTROL** again.

Using disc title functions

You can input CD titles and display the title. The next time you insert a CD for which you have entered a title, the title of that CD is displayed.

Entering disc titles

Use the disc title input feature to store up to 48 CD titles in the unit. Each title can be up to 10 characters long.

1 Play the CD that you want to enter a title for.

2 Use MULTI-CONTROL to select TitleInput "A" in the function menu.

Refer to *Introduction to advanced operations* on the previous page.

3 Press D/Scrl to select the desired character type.

Press **D/Scrl** repeatedly to switch between the following character types:

Alphabet (upper case), numbers and symbols
—Alphabet (lower case)—European letters, such as those with accents (e.g. **á, à, ä, ç**)—
Numbers and symbols

4 Push MULTI-CONTROL up or down to select a letter of the alphabet.

5 Push MULTI-CONTROL left or right to move the cursor to the previous or next character position.

6 Move the cursor to the last position by pushing MULTI-CONTROL right after entering the title.

When you push **MULTI-CONTROL** right one more time, the entered title is stored in memory.

7 Press B to return to the playback display.



Notes

- Titles remain in memory, even after the disc is removed from the unit, and are recalled when the disc is reinserted.
- After data for 48 discs are stored in the memory, data for a new disc overwrites the oldest one.
- If you connect a multi-CD player, you can input disc titles for up to 100 discs.
- When a multi-CD player that does not support disc title functions is connected, you cannot enter disc titles in this unit. 

Operating this unit

Playing songs in a USB storage device

You can play compressed audio files stored in a USB storage device.

- For details about compatibility, refer to *Additional Information* on page 66.

Basic Operations

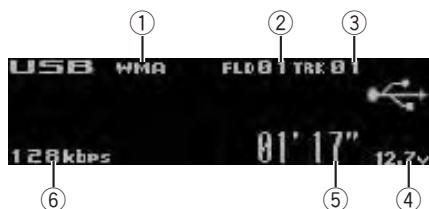

- ① **WMA/MP3/AAC/WAV** indicator
Shows the type of file currently playing.
- ② Folder number indicator
- ③ Track number indicator
- ④ Voltage indicator
Shows the battery voltage.
 - The level displayed on the voltage indicator may differ from the actual voltage level.
- ⑤ Play time indicator
- ⑥ Bit rate/sampling frequency indicator
 - When playing back VBR (variable bit rate)-recorded WMA files, the average bit rate value is displayed.
 - When playing back VBR (variable bit rate)-recorded MP3 files, **VBR** is displayed instead of bit rate value.

● **Plugging a USB storage device and playing**

- 1 Plug a USB storage device into the USB port.
Regarding the position of USB port, refer to *Head unit* on page 9.
- 2 Press **SRC/Off** to select **USB** as a source.
Playback will start.

● **Select a folder**

Push **MULTI-CONTROL** up or down.

● **Fast forward or reverse**

Push and hold **MULTI-CONTROL** left or right.

● **Select a track**

Push **MULTI-CONTROL** left or right.

● **Return to root folder**

Press and hold **B**.

● **Unplugging a USB storage device**

Pull out the USB storage device.

You can disconnect the USB storage device anytime you want to finish listening to it.

Notes

- Read the precautions for USB storage devices and this unit in the following section. Refer to *Additional Information*.
- If an error message is displayed, refer to *Error messages* on page 66.
- If folder 01 (ROOT) contains no files, playback commences with folder 02.
- When the USB portable audio player having battery charging function is connected to this unit and the ignition switch is set to ACC or ON, the battery is charged.

Displaying text information of an audio file

The operation is the same as that of the built-in CD player.

Refer to *Displaying text information on disc* on page 18.

- If the characters recorded on the audio file are not compatible with the head unit, those characters are not displayed.
- The text information of some audio files may not be correctly displayed.

Selecting files from the file name list

The operation is the same as that of the built-in CD player.

Refer to *Selecting files from the file name list* on page 19.

Introduction to advanced operations

1 Press **MULTI-CONTROL** to display the main menu.

2 Use **MULTI-CONTROL** to select **FUNCTION**.

Turn to change the menu option. Press to select.

3 Turn **MULTI-CONTROL** to select the function.

Play mode (repeat play)—**Random mode** (random play)—**Scan mode** (scan play)—**Pause** (pause)

- If you perform track search or fast forward/reverse during **Track repeat**, the repeat play range changes to **Folder repeat**.
- When **Folder repeat** is selected, it is not possible to play back a subfolder of that folder.
- After file or folder scanning is finished, normal playback of the files begins again.
- If you do not operate functions within about 30 seconds, the display automatically returns to the ordinary display. 

Function and operation

Play mode, **Random mode**, **Scan mode** and **Pause** operations are basically the same as that of the built-in CD player.

Function name	Operation
Play mode	Refer to <i>Selecting a repeat play range</i> on page 19. However, the repeat play ranges you can select are different from that of the built-in CD player. The repeat play ranges of the USB storage device are: <ul style="list-style-type: none"> • Track repeat – Repeat just the current file • Folder repeat – Repeat the current folder • All repeat – Repeat all files
Random mode	Refer to <i>Playing tracks in random order</i> on page 19.
Scan mode	Refer to <i>Scanning folders and tracks</i> on page 20.
Pause	Refer to <i>Pausing playback</i> on page 20.



Notes

- To return to the ordinary display, press **B**.
- If you select another folder during repeat play, the repeat play range changes to **All repeat**.

Operating this unit

Playing songs on iPod

You can control and listen to songs on an iPod.

- For details about the supported iPod, refer to *iPod compatibility* on page 70.
- When using an iPod, iPod Dock Connector to USB Cable is required.

Basic Operations

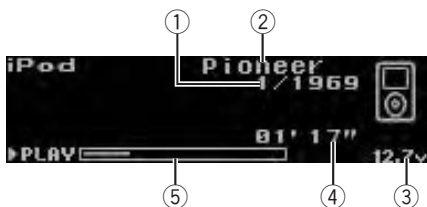

- ① Song number indicator
- ② iPod name
- ③ Voltage indicator
Shows the battery voltage.
 - The level displayed on the voltage indicator may differ from the actual voltage level.
- ④ Play time indicator
- ⑤ Song time (progress bar)

● Connecting an iPod

- 1 Plug an iPod into the USB port using the iPod Dock Connector to USB Cable. Regarding the position of USB port, refer to *Head unit* on page 9.
- 2 Press **SRC/Off** to select **iPod** as a source. Playback will start.

● Fast forward or reverse

Push and hold **MULTI-CONTROL** left or right.

● Select a track (chapter)

Push **MULTI-CONTROL** left or right.

● Disconnecting an iPod

Pull out the iPod Dock Connector to USB Cable.

Notes

- Read the precautions for iPod in the following section. Refer to page 70.

- If an error message is displayed, refer to *Error messages* on page 66.
- When the ignition switch is set to ACC or ON, the iPod's battery is charged while the iPod is connected to this unit.
- While the iPod is connected to this unit, the iPod cannot be turned on or off. However when the control mode is set to **iPod**, you can turn the iPod on or off.
- Before connecting the iPod to this unit, disconnect the headphones from the iPod.
- The iPod is turned off about two minutes after the ignition switch is set to OFF.

Browsing for a song

Operations to control an iPod with this unit is designed to be as close to the iPod as possible to make operation and song search easy.

- Depending on the number of files in the iPod, there may be a delay when displaying a list.
- If the characters recorded on the iPod are not compatible with this unit, those characters are not displayed.

Searching songs by category

● Use **MULTI-CONTROL** to select a song.

Turn to change the category. Press to select.

Playlists (playlists)—**Artists** (artists)—

Albums (albums)—**Songs** (songs)—**Podcasts**

(podcasts)—**Genres** (genres)—**Composers**

(composers)—**Audiobooks** (audiobooks)

List for the selected category is displayed.

- You can start playback throughout the selected category by pressing and holding

MULTI-CONTROL. You can also perform this operation by pushing and holding

MULTI-CONTROL right.

- You can also change the category by pushing **MULTI-CONTROL** up or down.

- You can also select the category by pushing **MULTI-CONTROL** right.

- To return to the previous category, push

MULTI-CONTROL left.

- To return to the top tier of categories, push and hold **MULTI-CONTROL** left.

Operating this unit

- You can scroll through text data by pressing and holding **D/Scrl**.
- To return to the ordinary display, press **B**.
- If you do not operate the list within about 30 seconds, the display automatically returns to the ordinary display.

Searching by alphabet in the list

1 Use **MULTI-CONTROL** to select a category.

Turn to change the category. Press to select.

2 When a list for the selected category is displayed, press **D/Scrl** to switch to alphabet search mode.

3 Turn **MULTI-CONTROL** to select a letter of the alphabet.

4 Press **MULTI-CONTROL** to display the alphabetical list.

The list is displayed starting from the selected letter of the alphabet.

- If alphabet search is aborted, **NOT FOUND** is displayed.

Displaying text information on iPod

● Press **D/Scrl** to select the desired text information.

Play time—: artist name and : song title
—: artist name and : album name—:
album name and : song title—: song title
and play time—: song title, : artist name
and : album name

- You can scroll through text data by pressing and holding **D/Scrl**.
- If the characters recorded on the iPod are not compatible with this unit, those characters are not displayed.
- When Ever Scroll is set to ON at the initial setting, text information scrolls continuously in the display. Refer to *Switching the ever scroll* on page 43.

Introduction to advanced operations

1 Press **MULTI-CONTROL** to display the main menu.

2 Use **MULTI-CONTROL** to select **FUNCTION**.

Turn to change the menu option. Press to select.

3 Turn **MULTI-CONTROL** to select the function.

Play mode (repeat play)—**Shuffle mode** (shuffle)—**Shuffle all** (shuffle all)—**Link play** (link play)—**Control mode** (control mode)—**Pause** (pause)—**Audiobooks** (audiobook speed)

Function and operation

Play mode and **Pause** operations are basically the same as that of the built-in CD player.

Function name	Operation
Play mode	Refer to <i>Selecting a repeat play range</i> on page 19. However, the repeat play ranges you can select are different from that of the built-in CD player. The repeat play ranges of the iPod are: <ul style="list-style-type: none"> • Repeat One – Repeat the current song • Repeat All – Repeat all songs in the selected list
Pause	Refer to <i>Pausing playback</i> on page 20.



Notes

- To return to the ordinary display, press **B**.
- If you do not operate functions within about 30 seconds, the display automatically returns to the ordinary display.
- When **Control mode** is set to **iPod**, only **Control mode** and **Pause** can be operated.

Operating this unit

Playing songs in a random order (shuffle)

1 Use MULTI-CONTROL to select Shuffle mode in the function menu.

Refer to *Introduction to advanced operations* on the previous page.

2 Press MULTI-CONTROL to select your favorite setting.

- **Shuffle Songs** – Play back songs in the selected list in random order.
- **Shuffle Albums** – Play back songs from a randomly selected album in order.
- **Shuffle OFF** – Cancel random play.

Playing all songs in a random order (shuffle all)

1 Use MULTI-CONTROL to select Shuffle all in the function menu.

Refer to *Introduction to advanced operations* on the previous page.

2 Press MULTI-CONTROL to turn shuffle all on.

All songs on the iPod play randomly.

- To turn shuffle all off, set **Shuffle mode** in the **FUNCTION** menu to off.

Playing songs related to the currently playing song

Songs related to the currently playing song are played. You can play songs of the following lists.

- Album list of currently playing artist
- Song list of currently playing album
- Album list of currently playing genre
- Depending on the number of files in the iPod, there may be a delay when displaying a list.

1 Use MULTI-CONTROL to select Link play in the function menu.

Refer to *Introduction to advanced operations* on the previous page.

2 Use MULTI-CONTROL to select the desired mode.

Push **MULTI-CONTROL** left or right to change the mode; press to select.

- **Artist** – Plays the album of currently playing artist.
- **Album** – Plays the song of currently playing album.
- **Genre** – Plays the album of currently playing genre.

Searching flashes while searching the list and then the playback of the list starts.

- If the related albums/songs are not found, **Not found** is displayed.

Operating this unit's iPod function from your iPod

This function cannot be operated with the following iPod models.

— iPod nano first generation

— iPod fifth generation

This unit's iPod function can be operated from your iPod. Sound can be heard from the car's speakers, and operation can be conducted from your iPod.

- While this function is in use, even if the ignition key is turned off, the iPod will not be turned off. To turn off power, operate the iPod.

1 Use MULTI-CONTROL to select Control mode in the function menu.

Refer to *Introduction to advanced operations* on the previous page.

2 Press MULTI-CONTROL to select your favorite setting.

- **iPod** – This unit's iPod function can be operated from the connected iPod.
- **AUDIO** – This unit's iPod function can be operated from this unit.

3 When you select iPod, operate the connected iPod to select a song and play.

- Switching the control mode to **iPod** pauses song playback. Operate the iPod to start playback.
- Even if the control mode is set to **iPod**, following functions are available from this unit.

Operating this unit

- Volume
- Fast forward/reverse
- Track up/down
- Pausing
- Switching the text information



Notes

- When the control mode is set to **iPod**, operations are limited as follows:
 - Functions other than **Control mode** (control mode) and **Pause** (pause) cannot be selected.
 - Browse function cannot be operated from this unit.
- Turning this function on pauses song playback. Operate the iPod to start playback.

Changing audiobook speed

While listening to an audiobook on iPod, playback speed can be changed.

1 Use **MULTI-CONTROL** to select Audiobooks in the function menu.

Refer to *Introduction to advanced operations* on page 24.

2 Press **MULTI-CONTROL** to select your favorite setting.

Press **MULTI-CONTROL** repeatedly until the desired setting appears in the display.

- **Faster** – Playback faster than normal speed
- **Normal** – Playback in normal speed
- **Slower** – Playback slower than normal speed 

Audio Adjustments

Operation modes

This unit's 4-way network DSP lets you create a 4-way multi-amp, multi-speaker system with separate speakers for reproduction of high, middle, low and ultra-low frequencies (bands), each driven by a dedicated power amp. The 4-way network mode provides network and time alignment functions. These two functions are essential for a multi-amp, multi-speaker system to enable precise control over settings for each frequency range.

Important

Even when the battery is disconnected or the microprocessor is reset, this unit's audio setting remains in the memory. If you want to reset the audio setting, refer to *Resetting the audio functions* on page 41.

Note

If one subwoofer is used with this system, left and right channel adjustment values, such as time alignment and network settings, need to be the same.

Adjusting the audio easily

By carrying out the following settings/adjustments in the order shown, you can create a finely-tuned sound field effortlessly.

- ① *Using the position selector (POSI)*
- ② *Auto TA and EQ (auto-time alignment and auto-equalizing)*
- ③ *Using balance adjustment on the next page (BAL)*

Adjusting the audio finely

By carrying out the following settings/adjustments in the order shown, you can create a finely-tuned sound field.

- ① *Adjusting the time alignment (TA2)*
- ② *Adjusting network (NW 1, NW 2, NW 3)*
- ③ *Fine-adjusting equalizer curve (EQ 2)*

Extra functions

These functions are helpful in adjusting the sound to suit your system or your personal preferences.

- *Recalling or copying equalizer curves (EQ 1)*
- *Adjusting loudness (LOUD)*
- *Using the sound retriever (S.Rtrv)*
- *Adjusting source levels (SLA)* 

Introduction of audio adjustments

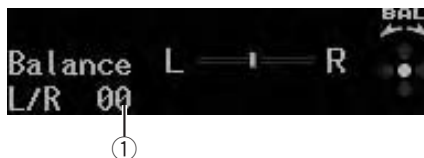

- ① **Audio display**
Shows the audio adjustment status.

1 Press MULTI-CONTROL to display the main menu.

2 Use MULTI-CONTROL to select AUDIO.
Turn to change the menu option. Press to select.

3 Turn MULTI-CONTROL to select the audio function.

Turn **MULTI-CONTROL** to switch between the audio functions in the following order.

BAL (balance adjustment)—**POSI** (position selector)—**NW 1** (network adjustment 1)—**NW 2** (network adjustment 2)—**NW 3** (network adjustment 3)—**TA1** (time alignment setting)—**TA2** (time alignment adjusting)—**EQ 1** (copying/recalling the equalizer)—**EQ 2** (31-band graphic equalizer)—**A.EQ** (auto-equalizer on/off)—**S.Rtrv** (advanced sound retriever)—**LOUD** (loudness)—**SLA** (source level adjustment)

- When selecting FM as the source, you cannot switch to **SLA**.
- When selecting **FLAT** in **EQ 1**, you cannot switch to **EQ 2**.
- When selecting **OFF** in **TA1**, you cannot switch to **TA2**.
- To return to the display of each source, press **B** .

Switching left and right channel

You can adjust following functions for left and right channel independently or commonly.

- *Adjusting network (NW 1, NW 2, NW 3)*
- *Fine-adjusting equalizer curve (EQ 2)*

1 Use MULTI-CONTROL to select the audio function described above.

2 Press MULTI-CONTROL and hold to switch between left/right independent mode and left/right common mode.

Each pressing and holding **MULTI-CONTROL** selects left/right independent mode and left/right common mode.

3 Press MULTI-CONTROL to select left channel or right channel when left/right independent mode has been selected.

Each pressing **MULTI-CONTROL** selects left channel and right channel.

4 Adjust these functions as desired. 

Using balance adjustment

You can select a balance setting that provides an ideal listening environment in all occupied seats.

1 Use MULTI-CONTROL to select BAL in the audio function menu.

Refer to *Introduction of audio adjustments* on the previous page.

2 Push MULTI-CONTROL left or right to adjust left/right speaker balance.

Each time **MULTI-CONTROL** is pushed left or right, the left/right speaker balance moves towards the left or right.

L 25 to R 25 is displayed as the left/right speaker balance moves from left to right. 

Using the position selector

One way to assure a more natural sound is to clearly position the stereo image, putting you right in the center of the sound field. The position selector function lets you automatically adjust the speakers' output levels and inserts

a delay time to match the number and position of occupied seats.

1 Use MULTI-CONTROL to select POS1 in the audio function menu.

Refer to *Introduction of audio adjustments* on the previous page.

2 Push MULTI-CONTROL left, right or up to select a listening position.

Direction	Display	Position
Left	Left	Front seat left
Right	Right	Front seat right
Up	Front	Front seats

- To cancel the selected listening position, push **MULTI-CONTROL** in the same direction again. 

About the network function

The network function lets you divide the audio signal into different frequency bands, and then reproduce each of them through separate speaker units.

You can then make precise adjustments to the reproduced frequency band (with a low-pass filter or high-pass filter), level, phase and other parameters to match the characteristics of each speaker unit.

Audio Adjustments

Adjustable parameters

The network function enables adjustment of the following parameters. Make adjustments in line with the reproduced frequency band and characteristics of each connected speaker unit.

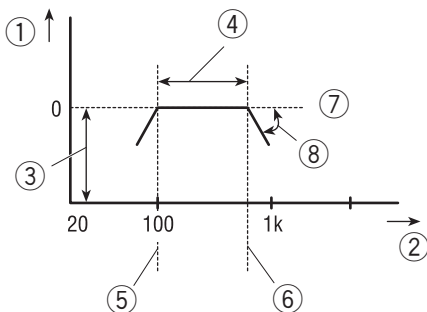

- ① Level (dB)
- ② Frequency (Hz)
- ③ Level
- ④ Reproduced frequency band
- ⑤ Cut-off frequency of HPF
- ⑥ Cut-off frequency of LPF
- ⑦ Pass
- ⑧ Slope (dB/oct.)

Reproduced frequency band

Adjusting the HPF (high-pass filter) or LPF (low-pass filter) cut-off frequency lets you set the reproduced frequency band for each speaker unit.

- The HPF cuts frequencies (low) below the set frequency, letting high frequencies through.
- The LPF cuts frequencies (high) above the set frequency, letting low frequencies through.

Level

The difference in reproduced levels between speaker units can be corrected.

Slope

Adjusting the HPF/LPF slope (filter attenuation slope) lets you adjust the continuity of sound between speaker units.

- The slope indicates the number of decibels (dB) the signal is attenuated when the frequency is one octave higher (lower) (Unit: dB/oct.). The steeper the slope, the more the signal is attenuated.

Phase

You can switch phase (normal, reverse) for each speaker unit's input signal. When the continuity of sound between speakers is imprecise, try switching phase. This may improve the continuity of sound between speakers.

Points concerning network adjustments

Cut-off frequency adjustment

- If you set the **Low-LPF** or **SW-LPF** cut-off frequency at a high level with a low-range speaker or subwoofer installed in the rear of the vehicle, the bass sound is separated so it sounds like it is coming from the rear. Setting the **Low-LPF** or **SW-LPF** cut-off frequency to 100 Hz or lower is recommended.
- The maximum input power setting for middle- and high-range speakers is usually lower than low-range speakers. Please be aware that if the **Mid-HPF** or **High-HPF** cut-off frequency is set lower than required, strong bass signal input may damage the speaker.

Level adjustment

The basic frequencies of many musical instruments are in the middle range. First perform middle-range level adjustment, followed by high-range and then low-range and subwoofer level adjustment in that order.

Slope adjustment

- If you set a small absolute value for the slope (for a gentle slope), interference between adjacent speaker units can easily result in degraded frequency response.

Audio Adjustments

- If you set a large absolute value for the slope (for a steep slope), continuity of sound between speaker units is degraded, and sounds appear to be separated.
- If you set the slope to 0 dB/oct. (pass), the audio signal bypasses the filter, so the filter does not have an effect.

Phase adjustment

When the cross-over point value for filters on both sides is set to -12 dB/oct., the phase is reversed 180 degrees at the filter cut-off frequency. In this case, reversing the phase assures improved sound continuity.

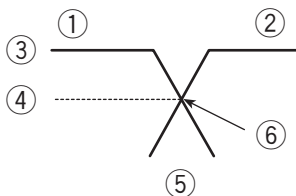

- ① Normal phase
- ② Reverse phase
- ③ 0 dB
- ④ -3 dB
- ⑤ -12 dB
- ⑥ Crossover point

Muting the speaker unit (filter)

You can mute each speaker unit (filter). When a speaker unit (filter) is muted, no sound is outputted from that speaker.

- If you mute the selected speaker unit (filter), **MUTE** blinks and no adjustments are possible.
- Even if any speaker unit (filter) is muted, you can adjust the parameters for other speaker units (filters).

1 Use MULTI-CONTROL to select NW 1 in the audio function menu.

Refer to *Introduction of audio adjustments* on page 27.

2 Push MULTI-CONTROL left or right to select the speaker unit (filter) to be adjusted.

Each time **MULTI-CONTROL** is pushed left or right, the speaker unit (filter) is selected in the following order:

SW-HPF (subwoofer HPF)—**SW-LPF** (subwoofer LPF)—**Low-HPF** (low-range speaker HPF)—**Low-LPF** (low-range speaker LPF)—**Mid-HPF** (middle-range speaker HPF)—**Mid-LPF** (middle-range speaker LPF)—**High-HPF** (high-range speaker HPF)—**High-LPF** (high-range speaker LPF)

3 Push and hold MULTI-CONTROL down to mute the selected speaker unit (filter).

- To cancel the muting, push **MULTI-CONTROL** up.

Adjusting network

1 Use MULTI-CONTROL to select NW 1 in the audio function menu.

Refer to *Introduction of audio adjustments* on page 27.

2 Push MULTI-CONTROL left or right to select the speaker unit (filter) to be adjusted.

Each time **MULTI-CONTROL** is pushed left or right, the speaker unit (filter) is selected in the following order:

SW-HPF (subwoofer HPF)—**SW-LPF** (subwoofer LPF)—**Low-HPF** (low-range speaker HPF)—**Low-LPF** (low-range speaker LPF)—**Mid-HPF** (middle-range speaker HPF)—**Mid-LPF** (middle-range speaker LPF)—**High-HPF** (high-range speaker HPF)—**High-LPF** (high-range speaker LPF)

3 Turn MULTI-CONTROL to select NW 2 in the audio function menu.

Refer to *Introduction of audio adjustments* on page 27.

Audio Adjustments

4 Push MULTI-CONTROL left or right to select the cut-off frequency (crossover frequency) of the selected speaker unit (filter).

Each time **MULTI-CONTROL** is pushed left or right, cut-off frequencies (crossover frequencies) are selected in the following order:

- **High-LPF**
5k—6.3k—8k—10k—12.5k—16k—20k
- **High-HPF**
800Hz—1k—1.25k—1.6k—2k—2.5k—
3.15k—4k—5k—6.3k—8k—10k—12.5k—
16k
- **Mid-LPF, Low-LPF and SW-LPF**
25Hz—31.5Hz—40Hz—50Hz—63Hz—
80Hz—100Hz—125Hz—160Hz—200Hz—
250Hz—315Hz—400Hz—500Hz—630Hz—
800Hz—1k—1.25k—1.6k—2k—2.5k—
3.15k—4k—5k—6.3k—8k—10k—12.5k—
16k—20k
- **Mid-HPF, Low-HPF and SW-HPF**
20Hz—25Hz—31.5Hz—40Hz—50Hz—
63Hz—80Hz—100Hz—125Hz—160Hz—
200Hz—250Hz—315Hz—400Hz—500Hz—
630Hz—800Hz—1k—1.25k—1.6k—2k—
2.5k—3.15k—4k—5k—6.3k—8k—10k—
12.5k—16k

■ You cannot select speakers that are set to off in the initial setting. Refer to *Setting the speakers* on page 38.

5 Push MULTI-CONTROL up or down to adjust the level of the selected speaker unit (filter).

Each time **MULTI-CONTROL** is pushed up or down, the level of the selected speaker unit (filter) increases or decreases.

0 dB to -24 dB is displayed as the level is increased or decreased if you have selected **High-LPF, High-HPF, Mid-LPF** or **Mid-HPF**.

6 dB to -24 dB is displayed as the level is increased or decreased, only if you have selected **Low-LPF, Low-HPF, SW-LPF** or **SW-HPF**.

6 Turn MULTI-CONTROL to select NW 3 in the audio function menu.

Refer to *Introduction of audio adjustments* on page 27.

7 Push MULTI-CONTROL left or right to select the slope of the selected speaker unit (filter).

Each time **MULTI-CONTROL** is pushed left or right, slopes are selected in the following order:

- **High-HPF**
6dB/oct.—12dB/oct.—18dB/oct.—
24dB/oct.—30dB/oct.—36dB/oct.
- **High-LPF, Mid-LPF, Mid-HPF, Low-LPF, Low-HPF, SW-LPF and SW-HPF**
Pass—6dB/oct.—12dB/oct.—18dB/oct.—
24dB/oct.—30dB/oct.—36dB/oct.

8 Push MULTI-CONTROL up or down to switch the phase of the selected speaker unit (filter).

Push **MULTI-CONTROL** up selects normal phase and **NOR** appears in the display. Push **MULTI-CONTROL** down selects reverse phase and **REV** appears in the display.

■ You can adjust the parameters for other speaker units (filters) in the same way.

9 Press B to cancel the network adjustment mode. 

Using the time alignment

The time alignment lets you adjust the distance between each speaker and the listening position.

1 Use MULTI-CONTROL to select TA1 in the audio function menu.

Refer to *Introduction of audio adjustments* on page 27.

Audio Adjustments

2 Push MULTI-CONTROL left or right to select the time alignment.

Each time **MULTI-CONTROL** is pushed left or right, time alignment is selected in the following order:

Initial (initial)—**Custom** (custom)—**AutoTA** (auto-time alignment)—**OFF** (off)

- **Initial** is the factory supplied time alignment.
- **Custom** is an adjusted time alignment that you created.
- **AutoTA** is the time alignment created by auto TA and EQ. (Refer to *Auto TA and EQ (auto-time alignment and auto-equalizing)* on page 34.)
- You cannot select **AutoTA** if auto TA and EQ has not been carried out. In this case,

Please Set Auto TA appears.

Adjusting the time alignment

You can adjust the distance between each speaker and the selected position.

- An adjusted time alignment is memorized in **Custom**.

1 Use MULTI-CONTROL to select TA1 in the audio function menu.

Refer to *Introduction of audio adjustments* on page 27.

2 Press MULTI-CONTROL to select a unit of distance.

Each press of **MULTI-CONTROL** selects the unit of distance in the following order: **(cm)** (centimeter)—**(inch)** (inch)

3 Use MULTI-CONTROL to select TA2 in the audio function menu.

Refer to *Introduction of audio adjustments* on page 27.

- **Can't Adjust TA. Set POS. FL or FR** appears when neither **Left** nor **Right** is selected in the position selector mode (**POSI**).
- When selecting **OFF** in **TA1**, you cannot switch to **TA2**.

4 Push MULTI-CONTROL left or right to select the speaker to be adjusted.

Each time **MULTI-CONTROL** is pushed left or right, the speaker is selected in the following order:

High L (high-range left)—**High R** (high-range right)—**Mid L** (middle-range left)—**Mid R** (middle-range right)—**Low L** (low-range left)—**Low R** (low-range right)—**SW L** (subwoofer left)—**SW R** (subwoofer right)

5 Push MULTI-CONTROL up or down to adjust the distance between the selected speaker and the listening position.

Each time **MULTI-CONTROL** is pushed up or down, the distance increases or decreases.

394.75cm to **0.00cm** is displayed as the distance is increased or decreased, if you have selected centimeters (**(cm)**).

155.39inch to **0.00inch** is displayed as the distance is increased or decreased, if you have selected inches (**(inch)**).

- You can adjust the distance for the other speakers in the same way.

6 Press B to cancel the time alignment mode.

Recalling or copying equalizer curves

The equalizer lets you adjust the equalization to match the car's interior acoustic characteristics as desired.

It is possible to store the adjusted equalizer curve in the memory, or recall the stored equalizer curve from the memory.

Recalling the equalizer curve

1 Use MULTI-CONTROL to select EQ 1 in the audio function menu.

Refer to *Introduction of audio adjustments* on page 27.

Audio Adjustments

2 Push MULTI-CONTROL left or right to select the equalizer curve you want to recall.

Each time **MULTI-CONTROL** is pushed left or right, equalizer curve is recalled in the following order.

MEMORY1 (memory 1)—**MEMORY2** (memory 2)—**MEMORY3** (memory 3)—**MEMORY4** (memory 4)—**MEMORY5** (memory 5)—**FLAT** (flat)

- When **FLAT** is selected, no supplement or correction is made to the sound. This is useful to check the effect of the equalizer curves by switching alternatively between **FLAT** and a set equalizer curve.

Copying the equalizer curve

1 Use MULTI-CONTROL to select EQ 1 in the audio function menu.

Refer to *Introduction of audio adjustments* on page 27.

2 Push MULTI-CONTROL left or right to select the equalizer curve you want to copy.

3 Press MULTI-CONTROL and hold to copy the selected equalizer curve.

4 Push MULTI-CONTROL left or right to select the storage area (MEMORY1 to MEMORY5).

5 Press MULTI-CONTROL and hold to store the equalizer curve.

Fine-adjusting equalizer curve

You can perform 31-band level adjustment to achieve the optimum acoustic characteristics for your vehicle's interior environment.

1 Select the storage area (MEMORY1 to MEMORY5).

Refer to *Copying the equalizer curve* on this page.

- If an equalizer curve has already been stored in memory, it will be overwritten by the newly adjusted equalizer curve.

2 Use MULTI-CONTROL to select EQ 2 in the audio function menu.

Refer to *Introduction of audio adjustments* on page 27.

3 Push MULTI-CONTROL left or right to select the equalizer band to adjust.

Each time **MULTI-CONTROL** is pushed left or right, equalizer bands are selected in the following order.

20Hz—25Hz—31.5Hz—40Hz—50Hz—63Hz—80Hz—100Hz—125Hz—160Hz—200Hz—250Hz—315Hz—400Hz—500Hz—630Hz—800Hz—1k—1.25k—1.6k—2kHz—2.5k—3.15k—4k—5k—6.3k—8k—10k—12.5kHz—16k—20k

4 Push MULTI-CONTROL up or down to adjust the level of the equalizer band.

Each time **MULTI-CONTROL** is pushed up or down, the level of the equalization band increases or decreases.

+12 to **-12** is displayed as the level is increased or decreased.

- You can then select another band and adjust the level.

5 Equalizer curve is automatically stored in memory.

Using the auto-equalizer

The auto-equalizer is the equalizer curve created by auto TA and EQ (refer to *Auto TA and EQ (auto-time alignment and auto-equalizing)* on the next page).

You can turn the auto-equalizer on or off.

1 Use MULTI-CONTROL to select A.EQ in the audio function menu.

Refer to *Introduction of audio adjustments* on page 27.

Audio Adjustments

- If auto TA and EQ has not been carried out, **Please Set Auto EQ** appears. This indicates that you cannot turn this function on.

2 Press MULTI-CONTROL to turn the auto-equalizer on.

- To turn auto-equalizer off, press **MULTI-CONTROL** again. 

Using the sound retriever

The sound retriever function automatically enhances compressed audio and restores rich sound.

1 Use MULTI-CONTROL to select S.Rtrv in the audio function menu.

Refer to *Introduction of audio adjustments* on page 27.

2 Press MULTI-CONTROL to select the desired setting.

OFF (off)—**MODE1**—**MODE2**

- **MODE1** is effective for the low compression rate.
- **MODE2** is effective for the high compression rate.
- This function can be used for the audio data stored in a CD, DVD, Bluetooth Audio, iPod, USB or AUX. 

Adjusting loudness

Loudness compensates for deficiencies in the low- and high-sound ranges at low volume.

1 Use MULTI-CONTROL to select LOUD in the audio function menu.

Refer to *Introduction of audio adjustments* on page 27.

2 Press MULTI-CONTROL to turn loudness on.

- To turn loudness off, press **MULTI-CONTROL** again. 

Adjusting source levels

SLA (source level adjustment) lets you adjust the volume level of each source to prevent radical changes in volume when switching between sources.

- Settings are based on the FM volume level, which remains unchanged.

1 Compare the FM volume level with the level of the source you wish to adjust.

2 Use MULTI-CONTROL to select SLA in the audio function menu.

Refer to *Introduction of audio adjustments* on page 27.

3 Push MULTI-CONTROL up or down to adjust the source volume.

Each time **MULTI-CONTROL** is pushed up or down, source volume increases or decreases. **+4** to **-4** is displayed as the source volume is increased or decreased.



Notes

- The MW/LW volume level can also be adjusted with source level adjustments.
- The built-in CD player and the multi-CD player are set to the same source level adjustment volume automatically.
- External unit 1 and external unit 2 are set to the same source level adjustment volume automatically. 

Auto TA and EQ (auto-time alignment and auto-equalizing)

The auto-time alignment is automatically adjusted for the distance between each speaker and the listening position.

The auto-equalizer automatically measures the car interior acoustic characteristics, and then creates the auto-equalizer curve based on that information.

Audio Adjustments

WARNING

- To prevent accidents, never carry out auto TA and EQ while driving. When this function measures the car interior acoustic characteristics to create an auto-equalizer curve, a loud measurement tone (noise) may be outputted from the speakers.
- Be sure to connect the high-range speakers to the high range output. If the speakers are not connected correctly, they may be damaged by the low frequency measurement tone.

CAUTION

- Carrying out auto TA and EQ under the following conditions may damage the speakers. Be sure to check the conditions thoroughly before carrying out auto TA and EQ.
 - When speakers are incorrectly connected. (e.g., When a mid-range speaker is connected to a subwoofer output.)
 - When a speaker is connected to a power amp delivering output higher than the speaker's maximum input power capability.
- If the microphone is placed in an unsuitable position the measurement tone may become loud and measurement may take a long time, resulting in a drain on battery power. Be sure to place the microphone in the specified location.
- When tweeters and super-tweeters are connected to this system, be sure to use the super-tweeter's cross-over network.
- When tweeters and super-tweeters are connected to this system, auto-time alignment and auto-equalizing may not operate properly. In this case, manual adjustment is needed.

Before operating the auto TA and EQ function

- Check the speaker's usable frequency range. Then connect the proper speakers to high, mid, low or subwoofer outputs. If the speakers are not connected correctly, auto-

time alignment and auto-equalizing may not perform properly.

- Carry out auto TA and EQ in as quiet a place as possible, with the car engine and air conditioning switched off. Also cut power to car phones or portable telephones in the car, or remove them from the car before carrying out auto TA and EQ. Sounds other than the measurement tone (surrounding sounds, engine sound, telephones ringing etc.) may prevent correct measurement of the car interior acoustic characteristics.
- Be sure to carry out auto TA and EQ using the supplied microphone. Using another microphone may prevent measurement, or result in incorrect measurement of the car interior acoustic characteristics.
- When the speakers activated in the initial setting menu are not connected, auto TA and EQ cannot be carried out.
- When the mid range speaker units are muted, auto TA and EQ cannot be carried out. (Refer to the next page.)
- When this unit is connected to a power amp with input level control, auto TA and EQ may not be possible if you lower power amp input level. Set the power amp's input level to the standard position.
- When this unit is connected to a power amp with an LPF, turn off the LPF on the power amp before carrying out auto TA and EQ. In addition, the cut-off frequency for built-in LPF of an active subwoofer should be set to the highest frequency.
- The time alignment value calculated by auto TA and EQ may differ from the actual distance in the following circumstances. However, the distance has been calculated by computer to be the optimum delay to give accurate results for the circumstances, so please continue to use this value.
 - When the reflected sound within a vehicle is strong and delays occur.

Audio Adjustments

- When delays occur for low sounds due to the influence of the LPF on active subwoofers or external amps.
- Auto TA and EQ changes the audio settings as below:
 - The balance settings return to the center position. (Refer to page 28.)
 - The graphic equalizer curve switches to **FLAT**. (Refer to page 32.)
- If you carry out auto TA and EQ when a previous setting of this already exists, the setting will be replaced.
- When connecting tweeters, please confirm the tweeter's usable frequency range. When you set the cut-off frequency, set higher than the lowest usable frequency of the tweeter.
- Auto TA uses higher range than 10 kHz for measurement. Therefore, using the tweeter that cannot reproduce 10 kHz frequency range may damage the tweeter. When Auto TA&EQ is operated, be sure to set the appropriate cut-off frequency. Also, use the tweeter that can reproduce 10 kHz at the lowest usable frequency.
- Speakers used with this system need to be activated in the initial setting menu. Refer to *Setting the speakers* on page 38.
- To perform auto-time alignment and auto-equalizing, be sure to connect speakers to mid range output.

Carrying out auto TA and EQ

1 Stop the car in a place that is as quiet as possible, close all doors, windows and the sun roof, and then turn the engine off.

- If the engine is left running, engine noise may prevent correct auto TA and EQ.

2 Fix the supplied microphone in the center of the headrest of the driver's seat, facing forward, using the belt (sold separately).

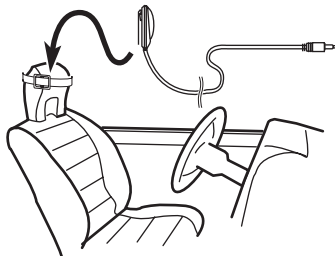

- The auto TA and EQ may differ depending on where you place the microphone. If desired, place the microphone on the front passenger seat to carry out auto TA and EQ.

3 Turn the ignition switch to ON or ACC.

- If the car's air conditioner or heater is turned on, turn it off. Noise from the fan in the air conditioner or heater may prevent correct auto TA and EQ.
 - Press **SRC/Off** to turn the source on if this unit is turned off.

4 Press SRC/Off and hold until the unit turns off.

5 Press and hold EQ to enter the auto TA and EQ menu.

The front panel opens automatically.

6 Plug the microphone into the microphone input jack on this unit.

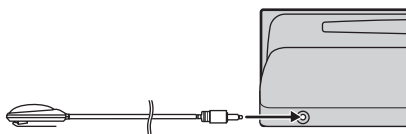

7 Turn MULTI-CONTROL to select Select position in the auto TA and EQ menu.

Audio Adjustments

8 Press MULTI-CONTROL to select a position.

Each press of **MULTI-CONTROL** selects settings in the following order:

Front left (front left)—**Front right** (front right)

Select the position for the seat on which the microphone is placed.

9 Turn MULTI-CONTROL to select Select N/W mode in the auto TA and EQ menu.

10 Press MULTI-CONTROL to select a network mode.

Each press of **MULTI-CONTROL** selects settings in the following order:

Auto N/W (auto)—**Custom N/W** (custom)

- If you want to carry out auto TA and EQ based on previously customized network settings, select **Custom N/W**. Otherwise, select **Auto N/W**.
- If manually adjusted value is not suitable for the actual specifications of the speakers, auto-time alignment and auto-equalizer may not perform properly.

11 Turn MULTI-CONTROL to select Auto TA & EQ stop in the auto TA and EQ menu.

12 Press MULTI-CONTROL to start the auto TA and EQ.

13 Get out of the car and close the door within 10 seconds when the 10-second count-down starts.

The measurement tone (noise) is outputted from the speakers, and auto TA and EQ begins.

- To stop auto TA and EQ, press

MULTI-CONTROL again.

- To cancel auto TA and EQ part way through, press **B**.

14 When auto TA and EQ is completed, Complete is displayed.

When correct measurement of car interior acoustic characteristics is not possible, an error message is displayed. (Refer to *Under-*

standing auto TA and EQ error messages on page 67.)

15 Press B to cancel the auto TA and EQ mode.

16 Store the microphone carefully in the glove compartment.

Store the microphone carefully in the glove compartment or any other safe place. If the microphone is subjected to direct sunlight for an extended period, high temperatures may cause distortion, color change or malfunction.



Note

Make sure you have disconnected the microphone before pressing **▲/Open** to open or close the panel (an alert sounds if the mic is still connected). **■**

Adjusting initial settings

Using the initial settings, you can customize various system settings to achieve optimal performance from this unit.

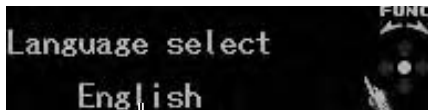

- ① Function display
Shows the function status.

- 1 Press **SRC/Off** and hold until the unit turns off.
- 2 Press **MULTI-CONTROL** and hold until the initial setting menu appears in the display.
- 3 Turn **MULTI-CONTROL** to select one of the initial settings.

Turn **MULTI-CONTROL** to switch between the functions in the following order.

Language select (language selection)—**SP connection** (speaker setting)—**Clock** (clock)—**Off clock** (off clock)—**FM step** (FM tuning step)—**Auto PI** (auto PI seek)—**Warning tone** (warning tone)—**Face auto open** (face auto open)—**AUX1** (auxiliary input 1)—**AUX2** (auxiliary input 2)—**Dimmer** (dimmer)—**Brightness** (brightness)—**Illumination 1** (illumination select)—**Illumination 2** (custom illumination)—**ILL line** (illumination interlock)—**Digital ATT** (digital attenuation)—**Audio Reset** (audio reset)—**Mute** (sound muting/attenuation)—**Door mute 1** (intelligent mute polarity setting)—**Door mute 2** (intelligent mute setting)—**Reverse mode** (reverse mode)—**Ever-scroll** (ever scroll)—**BT AUDIO** (Bluetooth audio)—**Pin code input** (pin code input)—**BT Version Info.** (Bluetooth version information)

Use the following instructions to operate each particular setting.

- **BT AUDIO, Pin code input** and **BT Version Info.** can be selected only when Bluetooth adapter (e.g., CD-BTB200) is connected to this unit.
- To cancel initial settings, press **B**.

Selecting the display language

For your convenience, this unit equips multiple language display. You can select the language best suited to your first language.

- 1 Use **MULTI-CONTROL** to select **Language select** in the initial setting menu. Refer to *Adjusting initial settings* on this page.

- 2 Press **MULTI-CONTROL** to select the language.

Each press of **MULTI-CONTROL** selects languages in the following order:

English—Français—Italiano—Español—Deutsch—Nederlands—РУССКИЙ

Setting the speakers

You need to set the speakers used with this system.

When this setting is performed correctly, this unit reproduces high-definition sound suited to your system.

- You cannot change the middle-range speaker setting. (The middle-range speaker is always on.)
- If this setting is adjusted after performing auto-time alignment and auto-equalizing function, perform auto-time alignment and auto-equalizing again.

- 1 Use **MULTI-CONTROL** to select **SP connection** in the initial setting menu. Refer to *Adjusting initial settings* on this page.

Initial Settings

2 Push MULTI-CONTROL left or right to select the speaker to be adjusted.

Each time **MULTI-CONTROL** is pushed left or right, the speaker is selected in the following order:

Subwoofer (subwoofer)—**Low range** (low range speaker)—**High range** (high range speaker)

3 Press MULTI-CONTROL to turn the selected speaker on.

- To turn off, press **MULTI-CONTROL** again. 

Setting the clock

Use these instructions to set the clock.

1 Use MULTI-CONTROL to select Clock in the initial setting menu.

Refer to *Adjusting initial settings* on the previous page.

2 Push MULTI-CONTROL left or right to select the segment of the clock display you wish to set.

Pushing **MULTI-CONTROL** left or right will select one segment of the clock display:

Hour—Minute

As you select segments of the clock display, the selected segment blinks.

3 Push MULTI-CONTROL up or down to put a clock right.

- You can match the clock to a time signal by pressing **MULTI-CONTROL**.
 - If **00** to **29**, the minutes are rounded down. (e.g., **10:18** becomes **10:00**.)
 - If **30** to **59**, the minutes are rounded up. (e.g., **10:36** becomes **11:00**.) 

Turning the off clock display on or off

If the off clock display is turned on and the sources are off, the clock display appears on the display.

1 Use MULTI-CONTROL to select Off clock in the initial setting menu.

Refer to *Adjusting initial settings* on the previous page.

2 Press MULTI-CONTROL to turn the off clock display on.

- To turn the off clock display off, press **MULTI-CONTROL** again. 

Setting the FM tuning step

Normally the FM tuning step employed by seek tuning is 50 kHz. When AF or TA is on, the tuning step automatically changes to 100 kHz. It may be preferable to set the tuning step to 50 kHz when AF is on.

1 Use MULTI-CONTROL to select FM step in the initial setting menu.

Refer to *Adjusting initial settings* on the previous page.

2 Press MULTI-CONTROL to select the FM tuning step.

Pressing **MULTI-CONTROL** repeatedly will switch the FM tuning step between 50 kHz and 100 kHz. The selected FM tuning step will appear in the display.

- The tuning step remains at 50 kHz during manual tuning. 

Switching Auto PI Seek

The unit can automatically search for a different station with the same programming, even during preset recall.

1 Use MULTI-CONTROL to select Auto PI in the initial setting menu.

Refer to *Adjusting initial settings* on the previous page.

2 Press MULTI-CONTROL to turn Auto PI seek on.

- To turn Auto PI seek off, press **MULTI-CONTROL** again. 

Switching the warning tone

If the front panel is not detached from the head unit within four seconds of turning off the ignition, a warning tone sounds. You can turn off the warning tone.

1 Use MULTI-CONTROL to select Warning tone in the initial setting menu.

Refer to *Adjusting initial settings* on page 38.

2 Press MULTI-CONTROL to turn warning tone on.

- To turn warning tone off, press **MULTI-CONTROL** again. 

Switching the face auto open

To protect against theft, this unit features detachable front panel. To detach the front panel easily, the front panel opens automatically. This function is on as a default.

1 Use MULTI-CONTROL to select Face auto open in the initial setting menu.

Refer to *Adjusting initial settings* on page 38.

2 Press MULTI-CONTROL to turn the face auto open on.

- To turn the face auto open off, press **MULTI-CONTROL** again. 

Switching the auxiliary setting

Auxiliary devices connected to this unit can be activated individually. Set each AUX source to ON when using. For more information about connecting or using auxiliary devices, refer to *Using the AUX source* on page 45.

1 Use MULTI-CONTROL to select AUX1/AUX2 in the initial setting menu.

Refer to *Adjusting initial settings* on page 38.

2 Press MULTI-CONTROL to turn AUX1/AUX2 on.

- To turn AUX off, press **MULTI-CONTROL** again. 

Switching the dimmer setting

To prevent the display from being too bright at night, the display is automatically dimmed when the car's headlights are turned on. You can turn the dimmer on or off.

1 Use MULTI-CONTROL to select Dimmer in the initial setting menu.

Refer to *Adjusting initial settings* on page 38.

2 Press MULTI-CONTROL to turn dimmer on.

- To turn dimmer off, press **MULTI-CONTROL** again. 

Adjusting the brightness

You can adjust the display brightness.

1 Use MULTI-CONTROL to select Brightness in the initial setting menu.

Refer to *Adjusting initial settings* on page 38.

2 Push MULTI-CONTROL left or right to adjust the brightness level.

0 to **15** is displayed as the level is increased or decreased.

- When dimmer is functioning, the brightness level can be adjusted **0** to **10**. 

Selecting the illumination color

You can select the illumination color from among White, Red, Amber, Green and Blue. Also, you can adjust brightness of each color.

1 Use MULTI-CONTROL to select Illumination 1 in the initial setting menu.

Refer to *Adjusting initial settings* on page 38.

Initial Settings

2 Push MULTI-CONTROL left or right to select the desired illumination color.

Each time **MULTI-CONTROL** is pushed left or right, the illumination color is selected in the following order:

White (white)—**Red** (red)—**Amber** (amber)—**Blue** (blue)—**Green** (green)—**Custom** (custom)

- If you select **Custom**, you can adjust the level of three primary colors such as red, green and blue. For details, *Adjusting the illumination color* on this page.

3 Push MULTI-CONTROL up or down to adjust the brightness level.

+1 to **-1** is displayed as the level is increased or decreased.

Adjusting the illumination color

You can create an illumination color by adjusting the level of the three primary colors, which are red, green and blue.

- This function can be used only when **Custom** is selected in **Illumination 1**.

1 Use MULTI-CONTROL to select Illumination 2 in the initial setting menu.

Refer to *Adjusting initial settings* on page 38.

2 Push MULTI-CONTROL left or right to select the color to adjust.

R (red)—**G** (green)—**B** (blue)

3 Push MULTI-CONTROL up or down to adjust the level of color.

4 to **0** is displayed as the level is increased or decreased.

Setting the illumination interlock

This unit's button illumination can be interlocked with either the ignition key or the vehi-

cle light switch. In this setting, you can select the appropriate option.

1 Use MULTI-CONTROL to select ILL line in the initial setting menu.

Refer to *Adjusting initial settings* on page 38.

2 Press MULTI-CONTROL to turn this function on.

When this function is on, the button illumination is interlocked with the vehicle light switch.

When this function is off, the button illumination is interlocked with the ignition switch.

- To turn off, press **MULTI-CONTROL** again.

Correcting distorted sound

When listening to a CD or other source on which the recording level is high, setting the level of each frequency to high may result in distortion. You can switch the digital attenuator to low to reduce distortion.

- Sound quality is better at the high setting so this setting is usually used.

1 Use MULTI-CONTROL to select Digital ATT in the initial setting menu.

Refer to *Adjusting initial settings* on page 38.

2 Press MULTI-CONTROL to select the digital attenuator level.

Pressing **MULTI-CONTROL** repeatedly will switch between **High** (high) and **Low** (low) and that status will be displayed.

Resetting the audio functions

You can reset all audio functions.

1 Use MULTI-CONTROL to select Audio Reset in the initial setting menu.

Refer to *Adjusting initial settings* on page 38.

2 Press MULTI-CONTROL. Reset data? appears in the display.

Initial Settings

3 Push MULTI-CONTROL right.

Are You Sure? appears in the display.

4 Press MULTI-CONTROL to reset audio functions.

Complete appears in the display and audio functions are reset.

- To cancel this function on the way, press **B**. 

Switching the sound muting/attenuation

Sound from this system is muted or attenuated automatically when the signal from the equipment with mute function is received.

- The sound is muted or attenuated, **MUTE** or **ATT** are displayed and no audio adjustment is possible.
- Sound from this system returns to normal when the muting or attenuation is canceled.

1 Use MULTI-CONTROL to select Mute in the initial setting menu.

Refer to *Adjusting initial settings* on page 38.

2 Press MULTI-CONTROL to switch the telephone muting/attenuation.

Each press of **MULTI-CONTROL** selects settings in the following order:

20dB ATT (20 dB attenuation)—**TEL mute** (mute)—**10dB ATT** (10 dB attenuation)

- **20dB ATT** has a stronger effect than **10dB ATT**. 

Setting the polarity of the door operation

Before using door mute function, it is necessary to set the polarity of the door operation. Check the polarity of the door opening operation, and set it correctly.

1 Use MULTI-CONTROL to select Door mute 1 in the initial setting menu.

Refer to *Adjusting initial settings* on page 38.

2 Press MULTI-CONTROL to select setting.

Each press of **MULTI-CONTROL** selects settings in the following order:

High (high)—**Low** (low)

- If the polarity changes to + (positive) when the door is opened, select **High**.
- If the polarity changes to – (negative) when the door is opened, select **Low**. 

Setting the door mute setting

Sound from this system is muted or attenuated automatically when the vehicle door is opened.

- Sound from this system returns to normal when the muting or attenuation is canceled.

1 Use MULTI-CONTROL to select Door mute 2 in the initial setting menu.

Refer to *Adjusting initial settings* on page 38.

2 Press MULTI-CONTROL to switch the door muting/attenuation.

Each press of **MULTI-CONTROL** selects settings in the following order:

OFF (off)—**20dB ATT** (20 dB attenuation)—**MUTE** (mute) 

Switching the reverse mode

If you do not perform an operation for about 30 seconds, screen indications start to reverse, and continue reversing every 10 seconds.

1 Use MULTI-CONTROL to select Reverse mode in the initial setting menu.

Refer to *Adjusting initial settings* on page 38.

2 Press MULTI-CONTROL to turn the reverse mode on.

- To turn the reverse mode off, press **MULTI-CONTROL** again.
- You can also turn on or off reverse mode by pressing **B** while this unit is turned off. For more details, refer to *Reverse mode* on page 7. 

Initial Settings

Switching the ever scroll

When ever scroll is set to on, literal information such as CD title scrolls continuously in the display. Set to off if you prefer the information to scroll just once.

1 Use MULTI-CONTROL to select Ever-scroll in the initial setting menu.

Refer to *Adjusting initial settings* on page 38.

2 Press MULTI-CONTROL to turn the ever scroll on.

- To turn the Ever Scroll off, press **MULTI-CONTROL** again. 

Activating the BT Audio source

You need to activate the **BT Audio** source in order to use a Bluetooth audio player.

- You can only operate this function when Bluetooth adapter (e.g. CD-BTB200) is connected to this unit.

1 Use MULTI-CONTROL to select BT AUDIO in the initial setting menu.

Refer to *Adjusting initial settings* on page 38.

2 Press MULTI-CONTROL to turn the BT Audio source on.

- To turn the **BT Audio** source off, press **MULTI-CONTROL** again. 

Entering PIN code for Bluetooth wireless connection

To connect your cellular phone to this unit via Bluetooth wireless technology, you need to enter PIN code on your phone to verify the connection. The default code is **0000**, but you can change this in this function.

- With some Bluetooth audio players, you may be required to enter the Bluetooth audio player PIN code in advance to set this unit for a connection.

- You can only operate this function when Bluetooth adapter (e.g. CD-BTB200) is connected to this unit.

1 Use MULTI-CONTROL to select Pin code input in the initial setting menu.

Refer to *Adjusting initial settings* on page 38.

2 Push MULTI-CONTROL up or down to select a number.

3 Push MULTI-CONTROL left or right to move the cursor to the previous or next position.

4 After inputting PIN code (up to 16 digits), press MULTI-CONTROL.

PIN code can be stored in memory.

When you press **MULTI-CONTROL** again on the same display, the PIN code you entered is stored in this unit.

- Pushing **MULTI-CONTROL** right in the confirmation display returns you to the PIN code input display, and you can change the PIN code. 

Displaying system version for repair

Should this unit fails to operate properly and you consult your dealer for repair, you may be asked to indicate the system versions of this unit and of Bluetooth module. You can display the versions and confirm them.

- You can only operate this function when Bluetooth adapter (e.g. CD-BTB200) is connected to this unit.

1 Use MULTI-CONTROL to select BT Version Info. in the initial setting menu.

Refer to *Adjusting initial settings* on page 38.

The system (microprocessor) version of this unit is displayed.

Initial Settings

2 Push MULTI-CONTROL left to switch to the version of the Bluetooth module of this unit.

- Pushing **MULTI-CONTROL** right returns to the system version of this unit.

Other Functions

Using the AUX source

Up to two auxiliary devices such as VCR or portable devices (sold separately) can be connected to this unit. When connected, auxiliary devices are automatically read as AUX sources and assigned to **AUX1** or **AUX2**. The relationship between **AUX1** and **AUX2** sources is explained below.

About AUX1 and AUX2

There are two methods to connect auxiliary devices to this unit.

AUX1 source:

When connecting auxiliary device using a 2.5 mm stereo plug cable

1 Press and hold \blacktriangle /Open to open the front panel.

AUX1 input jack appears.

2 Insert the 2.5 mm stereo plug into the AUX1 input jack on this unit.

This auxiliary device is automatically set to **AUX1**.

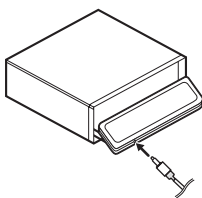

AUX2 source:

When connecting auxiliary device using an IP-BUS-RCA Interconnector (sold separately)

● **Use an IP-BUS-RCA Interconnector such as the CD-RB20/CD-RB10 (sold separately) to connect this unit to auxiliary device featuring RCA output.**

For more details, refer to the IP-BUS-RCA Interconnector owner's manual.

This auxiliary device is automatically set to **AUX2**.

■ You can only make this type of connection if the auxiliary device has RCA outputs.

Selecting AUX as the source

● **Press SRC/Off to select AUX (AUX1 or AUX2) as the source.**

■ If the auxiliary setting is not turned on, **AUX** cannot be selected. For more details, refer to *Switching the auxiliary setting* on page 40.

Setting the AUX title

The title displayed for the **AUX1** or **AUX2** source can be changed.

1 After you have selected AUX as the source, use MULTI-CONTROL and select FUNCTION to display TitleInput "A".

2 Enter a title in the same way as the built-in CD player.

For details concerning operation, refer to *Entering disc titles* on page 20. \square

Using the external unit

External unit refers to a Pioneer product (such as ones available in the future) that, although incompatible as a source, enables control of basic functions with this unit. Two external units can be controlled with this unit. When two external units are connected, the external unit is automatically allocated to external unit 1 or external unit 2 by this unit.

Basic operations of the external unit are explained below. Allocated functions are different depending on the connected external unit. For details concerning functions, refer to external unit's owner's manual.

Selecting the external unit as the source

● **Press SRC/Off to select EXTERNAL as the source.**

Basic operation

Functions allocated to the following operations are different depending on the connected external unit. For details concerning functions, refer to the connected external unit's owner's manual.

- **Press B.**
- **Press and hold B.**
- **Push MULTI-CONTROL left or right.**
- **Push and hold MULTI-CONTROL left or right.**
- **Push MULTI-CONTROL up or down.**

Advanced operations

1 Press MULTI-CONTROL to display the main menu.

2 Use MULTI-CONTROL to select FUNCTION.

Turn to change the menu option. Press to select.

3 Turn MULTI-CONTROL to select the function.

Function1 (function 1)—**Function2** (function 2)—**Function3** (function 3)—**Function4** (function 4)—**Auto/Manual** (auto/manual)

- To return to the ordinary display, press **B**. 

Using different entertainment displays

You can enjoy entertainment displays while listening to each sound source.

1 Press MULTI-CONTROL to display the main menu.

2 Use MULTI-CONTROL to select DISPLAY.

Turn to change the menu option. Press to select.

3 Use MULTI-CONTROL to change the display.

Turn to change the menu option. Press to select.

BASIC DISPLAY (basic display)—

SPECTRUM ANALYZER-1 (spectrum analyzer 1)—**SPECTRUM ANALYZER-2** (spectrum analyzer 2)—

LEVEL METER (level meter)—

DISPLAY OFF (display off)

- To return to the playback display, press **B**.
- You can also select **DISPLAY OFF** (display off) by pressing and holding **EQ**.
- While the display indication is turned off, display off indicator lights up. 

Using the DF (direct function) button

You can operate the preprogrammed functions for each source by using **DF** on the remote control.

● **Press DF to turn pause on when selecting the following sources:**

- **CD** – Built-in CD player
- **iPod** – iPod connected using USB input/ iPod connected with the interface adapter
- **Multi CD** – Multi-CD player
- **USB** – USB portable audio player/USB memory
- **BT Audio** – Bluetooth audio player
- **DVD** – DVD player/multi-DVD player

- To turn pause off, press **DF** again.

● **Press DF and hold to turn BSM on when selecting tuner as the source.**

Press **DF** and hold until the BSM turns on.

- To cancel the storage process, press **DF** again.

● **Press DF and hold to turn BSSM on when selecting television as the source.**

Press **DF** and hold until the BSSM turns on.

- To cancel the storage process, press **DF** again.

● **Press DF to turn function 1 on when selecting EXT (external unit 1/external unit 2) as the source.**

- To turn function 1 off, press **DF** again. 

Available accessories

Playing songs on iPod

Basic operation

You can use this unit to control an interface adapter for iPod (e.g. CD-IB100II), which is sold separately.



- ① Song number indicator
- ② Voltage indicator
Shows the battery voltage.
 - The level displayed on the voltage indicator may differ from the actual voltage level.
- ③ Play time indicator
- ④ Song time (progress bar)

● Fast forward or reverse

Push and hold **MULTI-CONTROL** left or right.

● Select a track







Push **MULTI-CONTROL** left or right.

Notes

- Read the precautions for iPod in the following section. Refer to page 70.
- If an error message is displayed, refer to *Error messages* on page 66.
- When the ignition switch is set to ACC or ON, the iPod's battery is charged while the iPod is connected to this unit.
- While the iPod is connected to this unit, the iPod cannot be turned on or off.
- Before connecting the iPod to this unit, disconnect the headphones from the iPod.
- The iPod is turned off about two minutes after the ignition switch is set to OFF.

Displaying text information on iPod

● Press D/Scrl to select the desired text information.

Play time—: artist name and : song title—: artist name and : album name—: album name and : song title—: song title and play time

- If the characters recorded on the iPod are not compatible with this unit, those characters are not displayed.

Notes

- You can scroll through text data by pressing and holding **D/Scrl**.
- When Ever Scroll is set to ON at the initial setting, text information scrolls continuously in the display. Refer to *Switching the ever scroll* on page 43.

Browsing for a song

The operation is the same as that of the iPod connected to USB interface of this unit. (Refer to *Browsing for a song* on page 23.)

However, the selectable categories are slightly different. Selectable categories are

Playlists (playlists)—**Artists** (artists)—**Albums** (albums)—**Songs** (songs)—**Genres** (genres)

- You cannot search songs by alphabet in the list while using an iPod with interface adapter.

Introduction to advanced operations

1 Press **MULTI-CONTROL** to display the main menu.

2 Use **MULTI-CONTROL** to select **FUNCTION**.

Turn to change the menu option. Press to select.

3 Turn MULTI-CONTROL to select the function.

Play mode (repeat play)—**Shuffle mode** (shuffle)—**Pause** (pause)

Function and operation

Play mode and **Pause** operations are basically the same as that of the built-in CD player.

Also, **Shuffle mode** operation is basically the same as that of iPod connected to USB interface of this unit.

Function name	Operation
Play mode	Refer to <i>Selecting a repeat play range</i> on page 19. However, the repeat play ranges you can select are different from that of the built-in CD player. The repeat play ranges of the iPod are: <ul style="list-style-type: none"> • Repeat One – Repeat the current song • Repeat All – Repeat all songs in the selected list
Shuffle mode	Refer to <i>Playing songs in a random order (shuffle)</i> on page 25.
Pause	Refer to <i>Pausing playback</i> on page 20.

Notes

- To return to the ordinary display, press **B**.
- If you do not operate functions within about 30 seconds, the display automatically returns to the ordinary display. 

Bluetooth Audio

If you connect a Bluetooth adapter (e.g. CD-BTB200) to this unit, you can control Bluetooth audio players via Bluetooth wireless technology.

- In some countries, CD-BTB200 is not sold on the market.

Basic Operations



- ① Device name
Shows the device name of the connected Bluetooth audio player (or Bluetooth adapter).
- ② Voltage indicator
Shows the battery voltage.
 - The level displayed on the voltage indicator may differ from the actual voltage level.



Important

- Depending on the Bluetooth audio player connected to this unit, the operations available with this unit are limited to the following two levels:
 - A2DP profile (Advanced Audio Distribution Profile): Only playing back songs on your audio player is possible.
 - AVRCP profile (Audio/Video Remote Control Profile): Playing back, pausing, selecting songs, etc., are possible.
- Since there are a number of Bluetooth audio players available on the market, operations with your Bluetooth audio player using this unit vary extensively. Refer to the instruction manual that came with your Bluetooth audio player as well as this manual while operating your player on this unit.
- Information about songs (e.g. the elapsed playing time, song title, song index, etc.) cannot be displayed on this unit.
- While you are listening to songs on your Bluetooth audio player, refrain from using on your cellular phone as much as possible. If you use your cellular phone, the signal from your cellular phone may cause noise on the song playback.

Available accessories

- When you are talking on a cellular phone connected to this unit via Bluetooth wireless technology, song playback from your Bluetooth audio player connected to this unit is muted.
- Even if you are listening to a song on your Bluetooth audio player and you switch to another source, song playback continues.

● **Fast forward or reverse**

Push and hold **MULTI-CONTROL** left or right.

● **Select a track**

Push **MULTI-CONTROL** left or right.

Notes

- For details concerning operation, refer to the Bluetooth adapter's operation manual. This section provides brief information on Bluetooth audio player operations with this unit, which slightly differs or is abbreviated from that described in the Bluetooth adapter's operation manual.
- Even though your audio player does not contain a Bluetooth module, you can still control it from this unit via Bluetooth wireless technology. To control your audio player using this unit, connect a product featuring Bluetooth wireless technology (available on the market) to your audio player and connect the Bluetooth adapter (e.g. CD-BTB200) to this unit.

Function and operation

1 **Press MULTI-CONTROL to display the main menu.**

2 **Use MULTI-CONTROL to select FUNCTION.**

Turn to change the menu option. Press to select.

3 **Turn MULTI-CONTROL to select the function.**

Connection open (connection open)—**Disconnect audio** (disconnect audio)—**Play** (play)—**Stop** (stop)—**Pause** (pause)—**Device info.** (device information)

- **Pause** is the same as that of the built-in CD player. (Refer to *Pausing playback* on page 20.)

Notes

- To return to the ordinary display, press **B**.
- If a Bluetooth audio player is not connected to this unit yet, **Connection open** and **Device info.** appear in the function menu and other functions are not available.
- If a Bluetooth audio player is connected via AVRCP (Audio/Video Remote Control Profile), **Connection open** does not appear in the function menu.
- If a Bluetooth audio player is connected via A2DP (Advanced Audio Distribution Profile), only **Disconnect audio** and **Device info.** appear in the function menu.
- If you do not operate functions other than **Connection open** and **Disconnect audio** within about 30 seconds, the display is automatically returned to the ordinary display.

Connecting a Bluetooth audio player

1 **Use MULTI-CONTROL to select Connection open in the function menu.**

Refer to *Function and operation* on this page.

2 **Press MULTI-CONTROL to open the connection.**

Always waiting is displayed. This unit is now on standby for connection from Bluetooth audio player.

If your Bluetooth audio player is set ready for Bluetooth wireless connection, connection to this unit is automatically established.

Note

Before you can use audio players you may need to enter the PIN code into this unit. If your player requires a PIN code to establish a connection, look for the code on the player or in its accompanying documentation. Refer to *Entering PIN code for Bluetooth wireless connection* on page 43.

Playing songs on a Bluetooth audio player

1 Use MULTI-CONTROL to select Play in the function menu.

Refer to *Function and operation* on the previous page.

2 Press MULTI-CONTROL to start playback.

Stopping playback

1 Use MULTI-CONTROL to select Stop in the function menu.

Refer to *Function and operation* on the previous page.

2 Press MULTI-CONTROL to stop the playback.

Disconnecting a Bluetooth audio player

1 Use MULTI-CONTROL to select Disconnect audio in the function menu.

Refer to *Function and operation* on the previous page.

2 Press MULTI-CONTROL to disconnect the Bluetooth audio player.

Disconnected is displayed. The Bluetooth audio player is now disconnected from this unit.

Displaying BD (Bluetooth Device) address

1 Use MULTI-CONTROL to select Device info. in the function menu.

Refer to *Function and operation* on the previous page.

2 Push MULTI-CONTROL left to switch to the BD address.

12-digit hexadecimal string is displayed.

- Pushing **MULTI-CONTROL** right returns to the device name. 

Bluetooth Telephone

If you use a Bluetooth adapter (e.g. CD-BTB200), you can connect a cellular phone featuring Bluetooth wireless technology to this unit for hands-free, wireless calls, even while driving.

- In some countries, CD-BTB200 is not sold on the market.

Basic Operations

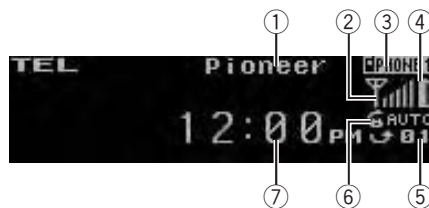

- Device name
Shows the device name of the cellular phone.
- Signal level indicator
Shows the signal strength of cellular phone.
 - The level shown on the indicator may differ from the actual signal level.
- User number indicator
Shows the registration number of the cellular phone.
- Battery strength indicator
Shows the battery strength of cellular phone.
 - The level shown on the indicator may differ from the actual battery strength.
 - If the battery strength is not available, nothing is displayed in the battery strength indicator area.
- Incoming call notice indication
Shows when an incoming call has been received and not checked yet.
 - Incoming call notice is not displayed for calls made when your cellular phone is disconnected from this unit.
- Automatic answering/Automatic rejecting indicator
Shows **AUTO** when the automatic answering function is on (for more details, refer to *Setting automatic answering* on page 58).

Available accessories

Shows **REFUSE** when the automatic rejecting function is on (for more details, refer to *Setting automatic rejecting* on page 58).

- ⑦ Clock display
Shows the time (if connected with a phone).



Important

- Since this unit is on standby to connect with your cellular phone via Bluetooth wireless technology, using this unit without running the engine can result in battery drainage.
- Advanced operations that require your attention such as dialing numbers on the monitor, using phone book, etc., are prohibited while you are driving. When you need to use these advanced operations, stop your vehicle in a safe place.



Notes

- The equalizer curve for the phone source is fixed.
- When selecting the phone source, you can only operate **Fader** (balance adjustment) in the audio menu.

Setting up for hands-free phoning

Before you can use the hands-free phoning function you must set up the unit for use with your cellular phone. This entails establishing a Bluetooth wireless connection between this unit and your phone, registering your phone with this unit, and adjusting the volume level.

1 Connection

For detailed instructions on connecting your phone to this unit via Bluetooth wireless technology, refer to *Connecting a cellular phone* on page 53.

- Your phone should now be temporarily connected. However, to make best use of the technology, we recommend you register the phone to this unit.

2 Registration

To register your temporarily connected phone, refer to *Registering a connected cellular phone* on page 53.

3 Volume adjustment

Adjust the earpiece volume on your cellular phone for comfort. When adjusted, the volume level is recorded in this unit as the default setting.

- Caller's voice volume and ring volume may vary depending on the type of cellular phone.
- If the difference between the ring volume and caller's voice volume is big, overall volume level may become unstable.
- Before disconnecting the cellular phone from this unit, make sure to adjust the volume to a proper level. If the volume is muted (zero level) on your cellular phone, the volume level of your cellular phone remains muted even after the cellular phone is disconnected.

Making a phone call

Voice recognition

1 Press B and hold until Voice dial appears in the display.

Voice dial appears in the display. When **Voice dial ON** is displayed, voice recognition function is now ready.

- If your cellular phone does not feature voice recognition function, **No voice dial** appears in the display and operation is not possible.

2 Pronounce the name of your contact.

Taking a phone call

Answering or rejecting an incoming call

● Answering an incoming call

When a call comes in, press

MULTI-CONTROL.

- You can also perform this operation by pushing **MULTI-CONTROL** up.

● End a call

Push **MULTI-CONTROL** down.

● Rejecting an incoming call

When a call comes in, push **MULTI-CONTROL** down.



Notes

- If private mode is selected on the cellular phone, hands-free phoning may not be performed.
- The estimated call time appears in the display (this may differ slightly from the actual call time).

Operating a call waiting

● Answering a call waiting

When a call comes in, press

MULTI-CONTROL.

- You can also perform this operation by pushing **MULTI-CONTROL** up.

● End all calls

Push **MULTI-CONTROL** down.

● Switch between callers on hold

Press **MULTI-CONTROL.**

- You can also perform this operation by pushing **MULTI-CONTROL** up.

● Rejecting call waiting

Push **MULTI-CONTROL** down.



Notes

- Pushing **MULTI-CONTROL** down ends all calls including calls waiting on line.
- To end the call, both you and your caller need to hang up the phone.

Function and operation

1 Press MULTI-CONTROL to display the main menu.

2 Use MULTI-CONTROL to select FUNCTION.

Turn to change the menu option. Press to select.

3 Turn MULTI-CONTROL to select the function.

Search&Connect (search and connect)—

Disconnect phone (disconnect phone)—

Connection open (connection open)—

Set phone (registering phone)—

Connect phone (connect phone)—

Delete phone (delete phone)—**PH.B.Transfer**

(phone book transfer)—**PH.B.Name view**

(phone book name view)—**Clear memory**

(clear memory)—**Number dial** (call by entering

number)—**Refuse calls** (automatic reject

setting)—**Auto answer** (automatic answer

setting)—**Ring tone** (ring tone select)—

Auto connect (automatic connection setting)

—**Echo cancel** (echo cancel)—**Device info.**

(device information)

If not connected yet

The following functions cannot be operated.

- **Disconnect phone** (disconnect phone)
- **Set phone** (registering phone)
- **PH.B.Name view** (phone book name view)
- **Clear memory** (clear memory)
- **Number dial** (call by entering number)

If connected but not registered yet

The following functions cannot be operated.

- **Search&Connect** (search and connect)
- **Connection open** (connection open)
- **Connect phone** (connect phone)
- **PH.B.Name view** (phone book name view)
- **Clear memory** (clear memory)

If already connected and registered

The following functions cannot be operated.

- **Search&Connect** (search and connect)
- **Connection open** (connection open)
- **Set phone** (registering phone)
- **Connect phone** (connect phone)



Notes

- To return to the playback display, press **B**.

Available accessories

- **Device info.** is the same as that of the Bluetooth audio. (Refer to *Displaying BD (Bluetooth Device) address* on page 50.)
- **PH.B.Name view** (phone book name view) cannot be selected for cellular phone registered guest phone.
- If cellular phone is connected to this unit via Bluetooth wireless technology with HSP (Head Set Profile), **PH.B.Name view**, **Clear memory**, **Number dial** and **Refuse calls** cannot be selected.
- If you do not operate functions other than **Search&Connect**, **Connection open**, **Connect phone**, **PH.B.Transfer**, **Disconnect phone**, **Number dial** and **Clear memory** within about 30 seconds, the display automatically returns to the ordinary display.

Connecting a cellular phone

Searching for available cellular phones

1 Use MULTI-CONTROL to select Search&Connect in the function menu.
Refer to *Function and operation* on the previous page.

2 Press MULTI-CONTROL to search for available cellular phones.
While searching, **Searching** flashes. When available cellular phones featuring Bluetooth wireless technology are found, device name or **Name not found** (if names cannot be obtained) is displayed.

- If this unit fails to find any available cellular phones, **Not found** is displayed.

3 Push MULTI-CONTROL up or down to select a device name you want to connect.
▪ Push **MULTI-CONTROL** left or right to switch the BD address and device name.

4 Press MULTI-CONTROL to connect the selected cellular phone.
While connecting, **Connecting** flashes. To complete the connection, check the device name (**Pioneer BT Unit**) and enter the link code on your cellular phone. If the connection is established, **Connected** is displayed.

- PIN code is set to **0000** as the default. You can change this code. Refer to *Entering PIN code for Bluetooth wireless connection* on page 43.

Using a cellular phone to initiate a connection

1 Use MULTI-CONTROL to select Connection open in the function menu.
Refer to *Function and operation* on the previous page.

2 Press MULTI-CONTROL to open the connection.
Always waiting flashes and the unit is now on standby for connection from a cellular phone.

3 Use cellular phone to connect to this unit.
▪ PIN code is set to **0000** as the default. You can change this code. Refer to *Entering PIN code for Bluetooth wireless connection* on page 43.

Disconnecting a cellular phone

1 Use MULTI-CONTROL to select Disconnect phone in the function menu.
Refer to *Function and operation* on the previous page.
Device name of the connected phone appears in the display.

2 Press MULTI-CONTROL to disconnect a cellular phone from this unit.
After disconnection is completed, **Disconnected** is displayed.

Registering a connected cellular phone

1 Use MULTI-CONTROL to select Set phone in the function menu.
Refer to *Function and operation* on the previous page.

Available accessories

2 Push MULTI-CONTROL up or down to select a pairing assignment.

P1 (user phone 1)—**P2** (user phone 2)—**P3** (user phone 3)—**G1** (guest phone 1)—**G2** (guest phone 2)

- Push **MULTI-CONTROL** left or right to switch the BD address and device name.
- As you select each assignment, you can see whether or not a phone is already registered. If the assignment is empty, **No data** is displayed. If the assignment is already taken, the device name appears. To replace an assignment with a new phone, first delete the current assignment. For more detailed instructions, see *Deleting a registered phone* on this page.

3 Press MULTI-CONTROL to register the currently connected phone.

When registration is completed,

Reg.Completed is displayed.

- If the registration fails, **Reg.ERROR** is displayed. In this case, return to step 1 and try again.

Deleting a registered phone

1 Use MULTI-CONTROL to select Delete phone in the function menu.

Refer to *Function and operation* on page 52.

2 Push MULTI-CONTROL up or down to select a pairing assignment.

P1 (user phone 1)—**P2** (user phone 2)—**P3** (user phone 3)—**G1** (guest phone 1)—**G2** (guest phone 2)

- Push **MULTI-CONTROL** left or right to switch the BD address and device name.
- If the assignment is empty, **No data** is displayed and operation is not possible.

3 Push MULTI-CONTROL right to select Delete YES.

Delete YES is displayed. Deleting phone is now on standby.

4 Press MULTI-CONTROL to delete the phone.

After the phone is deleted, **Deleted** is displayed.

Connecting to a registered cellular phone

Connecting to a registered phone manually

1 Use MULTI-CONTROL to select Connect phone in the function menu.

Refer to *Function and operation* on page 52.

2 Push MULTI-CONTROL up or down to select a pairing assignment.

P1 (user phone 1)—**P2** (user phone 2)—**P3** (user phone 3)—**G1** (guest phone 1)—**G2** (guest phone 2)

- Push **MULTI-CONTROL** left or right to switch the BD address and device name.
- If the assignment is empty, **No data** is displayed and operation is not possible.

3 Press MULTI-CONTROL to connect the selected cellular phone.

While connecting, **Connecting** is displayed. After the connection is completed, **Connected** is displayed.

Connecting to a registered phone automatically

1 Use MULTI-CONTROL to select Auto connect in the function menu.

Refer to *Function and operation* on page 52.

2 Press MULTI-CONTROL to turn automatic connection on.

If your cellular phone is ready for Bluetooth wireless connection, connection to this unit is automatically established.

- To turn automatic connection off, press **MULTI-CONTROL** again.

Using the phone book

Transferring entries to the phone book

The Phone Book can hold a total of 500 entries. 300 from User 1, 150 from User 2, and 50 from User 3.

1 Use MULTI-CONTROL to select PH.B.Transfer in the function menu.

Refer to *Function and operation* on page 52.

Available accessories

2 Press MULTI-CONTROL to enter the phone book transfer standby mode.

Transfer YES appears in the display.

3 Press MULTI-CONTROL to show the confirmation display.

Transfer -/- appears in the display.

4 Use the cellular phone to perform phone book transfer.

Perform phone book transfer using the cellular phone. For detailed instructions, refer to the instruction manual that came with your cellular phone.

- The display indicates how many entries have been transferred and the total number to be transferred.

5 Data transferred is displayed and phone book transfer is completed.

Changing the phone book display order

1 Use MULTI-CONTROL to select PH.B.Name view in the function menu.

Refer to *Function and operation* on page 52.

Invert names YES appears in the display.

2 Press MULTI-CONTROL to change the name view order.

Inverted is displayed and the name view order is changed.

Pressing MULTI-CONTROL repeatedly changes the name view order between first and last name.

Calling a number in the phone book



Important

Be sure to park your vehicle and apply the parking brake when performing this operation.

After finding the number you want to call in the phone book, you can select the entry and make the call.

1 Turn MULTI-CONTROL to display the list.

2 Press D/Scrl to display the phone book.

Press D/Scrl repeatedly to switch between the following lists:

Phone book—Missed call—Dialled call—Received call

3 Push MULTI-CONTROL left or right to select the first letter of the name you are looking for.

4 Press MULTI-CONTROL to display entries.

The display shows the first three Phone Book entries starting with that letter (e.g. “Ben”, “Brian” and “Burt” when “B” is selected).

5 Push MULTI-CONTROL up or down to select a Phone Book entry you want to call.

- You can scroll through text data by pressing and holding D/Scrl.

6 Push MULTI-CONTROL right to display the detailed list of the selected entry.

The phone number, name and genre (if assigned) of entries are displayed in the detailed list.

- You can scroll through text data by pressing and holding D/Scrl.

- If several phone numbers are included in an entry, select one by turning MULTI-CONTROL.

- If you want to go back and select another entry, push MULTI-CONTROL left.

7 Press MULTI-CONTROL to make a call.

8 To end the call, push MULTI-CONTROL down.

Editing the name of a Phone Book entry



Important

Be sure to park your vehicle and apply the parking brake when performing this operation.

You can edit the names of Phone Book entries. Each name can be up to 16 characters long.

1 Display the detailed list of your desired Phone Book entry.

Please see Steps 1 to 6 of the following section for how to do this. Refer to *Calling a number in the phone book* on this page.

Available accessories

2 Press and hold MULTI-CONTROL to display the name input screen.

Edit name is displayed.

3 Press D/Scrl to select the desired character type.

Each press of **D/Scrl** switches the character types in the following order:

Alphabet (upper case), numbers and symbols—alphabet (lower case)—numbers and symbols—European characters, such as those with accents (e.g., **á, à, ä, ç**) or Russian characters

- Pressing and holding **D/Scrl** enables you to switch character set between ISO8859-1 (European characters) and ISO8859-5 (Russian characters) alternately.
- European characters and Russian characters can't be mixed.

4 Push MULTI-CONTROL up or down to select a letter.

- To delete a character and leave a space, select " _ " (underbar).

5 Push MULTI-CONTROL left or right to move the cursor to the previous or next character position.

6 Press MULTI-CONTROL to store the new name.

3 Turn MULTI-CONTROL to switch to the number input screen.

Edit name (name input screen)—

Edit number (number input screen)—

Clear memory (clear memory screen)

4 Push MULTI-CONTROL left or right to move the cursor to the number you want to change.

5 Push MULTI-CONTROL up or down to change numbers.

Repeat these steps until you have finished changing.

6 Press MULTI-CONTROL to store the new number.

Editing phone numbers



Important

Be sure to park your vehicle and apply the parking brake when performing this operation.

You can edit the numbers of Phone Book entries. Each phone number can be up to 24 digits long.

1 Display the detailed list of your desired Phone Book entry.

Please see Steps 1 to 6 of the following section for how to do this. Refer to *Calling a number in the phone book* on the previous page.

2 Press and hold MULTI-CONTROL to display the name input screen.

Edit name is displayed.

Available accessories

Clearing a phone book entry



Important

Be sure to park your vehicle and apply the parking brake when performing this operation.

1 Display the detailed list of your desired Phone Book entry.

Please see Steps 1 to 6 of the following section for how to do this. Refer to *Calling a number in the phone book* on page 55.

2 Press and hold MULTI-CONTROL to display the name input screen.

Edit name is displayed.

3 Turn MULTI-CONTROL to switch to the clear memory screen.

Edit name (name input screen)—

Edit number (number input screen)—

Clear memory (clear memory screen)

4 Push MULTI-CONTROL right to show a confirmation display.

Clear memory YES is displayed.

- If you do not want to clear the memory that you have selected, push **MULTI-CONTROL** left. The display reverts to normal.

5 Press MULTI-CONTROL to delete the Phone Book entry.

Cleared is displayed.

The Phone Book entry is deleted. The display returns to Phone Book entry list.

Using the call history



Important

Be sure to park your vehicle and apply the parking brake when performing this operation.

The 12 most recent calls made (dialled), received and missed, are stored in the call history. You can browse the call history and call numbers from it.

1 Turn MULTI-CONTROL to display the list.

2 Press D/Scrl to display the phone book.

Press **D/Scrl** repeatedly to switch between the following lists:

Phone book—Missed call—Dialled call—Received call

- For more details about the Phone Book list, refer to *Using the phone book* on page 54.

- If no phone numbers are stored in the selected list, **No data** is displayed.

3 Turn MULTI-CONTROL to select a phone number.

Turning **MULTI-CONTROL** to change the phone numbers stored in the list.

- If the phone number is already in the phone book, the corresponding name is displayed.

- You can also change the phone number by pushing **MULTI-CONTROL** up or down.

4 Push MULTI-CONTROL right to display the detailed list.

Name and phone number are displayed in the detailed list.

- If the number is already in the Phone Book then the name is also displayed.

- Turning **MULTI-CONTROL** switches to the previous or next phone number displayed in the detailed list.

- If you do not operate functions other than *Editing the name of a Phone Book entry* and *Editing phone numbers* within about 30 seconds, the display automatically returns to the ordinary display.

5 Press MULTI-CONTROL to make a call.

- For an international call, press and hold **MULTI-CONTROL** to add **+** to the phone number.

6 To end the call, push MULTI-CONTROL down.

Making a call by entering phone number



Important

Be sure to park your vehicle and apply the parking brake when performing this operation.

Available accessories

1 Use MULTI-CONTROL to select Number dial in the function menu.

Refer to *Function and operation* on page 52.

2 Push MULTI-CONTROL up or down to select a number.

3 Push MULTI-CONTROL left or right to move the cursor to the previous or next position.

- Up to 24 digits can be entered.

4 When you finish entering the number, press MULTI-CONTROL.

Call confirmation appears.

- Pushing **MULTI-CONTROL** right in the confirmation display returns you to the number input display, and you can reenter the phone number.

5 Press MULTI-CONTROL to make a call.

6 To end the call, push MULTI-CONTROL down.

Clearing memory

1 Use MULTI-CONTROL to select Clear memory in the function menu.

Refer to *Function and operation* on page 52.

2 Push MULTI-CONTROL up or down to select an item.

Each time **MULTI-CONTROL** is pushed up or down, the items are switched in the following order:

Phone book (phone book)—**Missed calls** (missed call history)—**Dialed calls** (dialed call history)—**Received calls** (received call history)—**Dial preset** (preset phone numbers)—**All clear** (delete all memory)

- If you want to clear all the Phone Book, dialed/received/missed call history list and preset phone number, select **All clear**.
- If guest phone is connected to this unit via Bluetooth wireless technology, **Phone book** cannot be selected.

3 Push MULTI-CONTROL right to determine the item that you want to delete from this unit.

Clear memory YES is displayed. Clearing memory is now on standby.

- If you do not want to clear the memory that you have selected, push **MULTI-CONTROL** left. The display reverts to normal.

4 Press MULTI-CONTROL to clear the memory.

Cleared is displayed and data on the selected item is cleared from this unit's memory.

Setting automatic rejecting

1 Use MULTI-CONTROL to select Refuse calls in the function menu.

Refer to *Function and operation* on page 52.

2 Press MULTI-CONTROL to turn automatic call rejection on.

- To turn automatic call rejection off, press **MULTI-CONTROL** again.

Setting automatic answering

1 Use MULTI-CONTROL to select Auto answer in the function menu.

Refer to *Function and operation* on page 52.

2 Press MULTI-CONTROL to turn automatic answering on.

- To turn automatic answering function off, press **MULTI-CONTROL** again.

Switching the ring tone

1 Use MULTI-CONTROL to select Ring tone in the function menu.

Refer to *Function and operation* on page 52.

2 Press MULTI-CONTROL to turn the ring tone on.

- To turn the ring tone off, press **MULTI-CONTROL** again.

Available accessories

Echo canceling and noise reduction

1 Use MULTI-CONTROL to select Echo cancel in the function menu.

Refer to *Function and operation* on page 52.

2 Press MULTI-CONTROL to turn echo canceling on.

- To turn echo canceling off, press MULTI-CONTROL again.

Multi-CD Player

Basic Operations

You can use this unit to control a multi-CD player, which is sold separately.

- Only functions described in this section can be operated.
- Only functions described in this manual are supported by 50-disc multi-CD players.
- This unit is not designed to operate disc title list functions with a 50-disc multi-CD player. For information about the disc title list functions, refer to *Selecting discs from the disc title list* on page 62.



- ① Disc number indicator
- ② Track number indicator
- ③ Voltage indicator
 - Shows the battery voltage.
 - The level displayed on the voltage indicator may differ from the actual voltage level.
- ④ Play time indicator

● Select a disc

Push MULTI-CONTROL up or down.

● Fast forward or reverse

Push and hold MULTI-CONTROL left or right.

● Select a track

Push MULTI-CONTROL left or right.

Notes

- When multi-CD player completes preparatory operations, **READY** is displayed.
- If an error message is displayed, refer to the multi-CD player owner's manual.
- If there are no discs in the multi-CD player magazine, **NO DISC** is displayed.

Using CD TEXT functions

You can use these functions only with a CD TEXT compatible multi-CD player.

The operation is the same as that of the built-in CD player.

Refer to *Displaying text information on disc* on page 18.

Introduction to advanced operations

You can only use **Compression** (compression and DBE) with a multi-CD player that supports them.

1 Press MULTI-CONTROL to display the main menu.

2 Use MULTI-CONTROL to select FUNCTION.

Turn to change the menu option. Press to select.

3 Turn MULTI-CONTROL to select the function.

Play mode (repeat play)—**Random mode** (random play)—**Scan mode** (scan play)—**Pause** (pause)—**Compression** (compression and DBE)—**ITS play mode** (ITS play)—**ITS memo** (ITS programming)—**Titleinput "A"** (disc title input)

- If you do not operate functions other than **ITS memo** and **Titleinput "A"** within about 30 seconds, the display automatically returns to the ordinary display.

Available accessories

- When playing a CD TEXT disc on a CD TEXT compatible multi-CD player, you cannot switch to **TitleInput "A"**. The disc title is already recorded on the CD TEXT disc.

Function and operation

Play mode, **Random mode**, **Scan mode**, **Pause** and **TitleInput "A"** operations are basically the same as that of the built-in CD player.

Function name	Operation
Play mode	Refer to <i>Selecting a repeat play range</i> on page 19. However, the repeat play ranges you can select are different from that of the built-in CD player. The repeat play ranges of the multi-CD player are: <ul style="list-style-type: none"> M-CD repeat – Repeat all discs in the multi-CD player Track repeat – Repeat just the current track Disc repeat – Repeat the current disc
Random mode	Refer to <i>Playing tracks in random order</i> on page 19.
Scan mode	Refer to <i>Scanning folders and tracks</i> on page 20.
Pause	Refer to <i>Pausing playback</i> on page 20.
TitleInput "A"	Refer to <i>Entering disc titles</i> on page 20.



Notes

- To return to the playback display, press **B**.
- If you select other discs during repeat play, the repeat play range changes to **M-CD repeat**.
- If you perform track search or fast forward/reverse during **Track repeat**, the repeat play range changes to **Disc repeat**.
- After track or disc scanning is finished, normal playback of the tracks begins again.

Using compression and bass emphasis

You can only use these functions with a multi-CD player that supports them.

COMP (compression) and DBE (dynamic bass emphasis) functions lets you adjust the sound playback quality of the multi-CD player.

1 Use MULTI-CONTROL to select Compression in the function menu.

Refer to *Introduction to advanced operations* on the previous page.

- If the multi-CD player does not support COMP/DBE, **No COMP** is displayed when you attempt to select it.

2 Press MULTI-CONTROL to select your favorite setting.

COMP OFF—COMP 1—COMP 2—COMP OFF—DBE 1—DBE 2

Using ITS playlists

ITS (instant track selection) lets you make a playlist of favorite tracks from the multi-CD player magazine. After you have added your favorite tracks to the playlist, you can turn on ITS play and play just those selections. You can use ITS to enter and play back up to 99 tracks per disc from up to 100 discs (with the disc titles). (With multi-CD players sold before the CDX-P1250 and CDX-P650, up to 24 tracks can be stored in the playlist.)

Creating a playlist with ITS programming

1 Play a CD that you want to program.

Push **MULTI-CONTROL** up or down to select the CD.

2 Use MULTI-CONTROL to select ITS memo in the function menu.

Refer to *Introduction to advanced operations* on the previous page.

3 Select the desired track by pushing MULTI-CONTROL left or right.

Available accessories

4 Push **MULTI-CONTROL** up to store the currently playing track in the playlist.

Memory complete is displayed and the currently playing selection is added to your playlist.

5 Press **B** to return to the playback display.



Note

After data for 100 discs is stored in memory, data for a new disc will overwrite the oldest one.

Playback from your ITS playlist

ITS play lets you listen to the tracks that you have entered into your ITS playlist. When you turn on ITS play, tracks from your ITS playlist in the multi-CD player begin to play.

1 Select the repeat range.

Refer to *Playing tracks in random order* on page 19.

2 Use **MULTI-CONTROL** to select ITS play mode in the function menu.

Refer to *Introduction to advanced operations* on page 59.

3 Press **MULTI-CONTROL** to turn ITS play on.

ITS play appears in the display. Playback begins of those tracks from your playlist within the previously selected **M-CD repeat** or **Disc repeat** ranges.

- If no tracks in the current range are programmed for ITS play, then **ITS empty** is displayed.
- To turn ITS play off, press **MULTI-CONTROL** again.

Erasing a track from your ITS playlist

You can delete a track from your ITS playlist if ITS play is on.

If ITS play is already on, skip to step 2. If ITS play is off, use **MULTI-CONTROL**.

1 Play the CD with the track you want to delete from your ITS playlist, and turn ITS play on.

Refer to *Playback from your ITS playlist* on this page.

2 Use **MULTI-CONTROL** to select ITS memo in the function menu.

Refer to *Introduction to advanced operations* on page 59.

3 Select the desired track by pushing **MULTI-CONTROL** left or right.

4 Push **MULTI-CONTROL** down to erase the track from your ITS playlist.

The currently playing selection is erased from your ITS playlist and playback of the next track begins.

- If there are no tracks from your playlist in the current range, **ITS empty** is displayed and normal playback resumes.

5 Press **B** to return to the playback display.

Erasing a CD from your ITS playlist

You can delete all tracks of a CD from your ITS playlist if ITS play is off.

1 Play the CD that you want to delete.

Push **MULTI-CONTROL** up or down to select the CD.

2 Use **MULTI-CONTROL** to select ITS memo in the function menu.

Refer to *Introduction to advanced operations* on page 59.

3 Push **MULTI-CONTROL** down to erase all tracks on the currently playing CD from your ITS playlist.

All tracks on the currently playing CD are deleted from your playlist and **Memory deleted** is displayed.

4 Press **B** to return to the playback display.

Using disc title functions

You can input CD titles and display the titles. Then, you can easily search for and play a desired disc.

Entering disc titles

Use the disc title input feature to store up to 100 CD titles (with ITS playlist) into the multi-CD player. Each title can be up to 10 characters long.

For details concerning operation, refer to *Entering disc titles* on page 20.

- Titles remain in the memory even after the disc is removed from the magazine, and are recalled when the disc is reinserted.
- After data for 100 discs is stored in memory, data for a new disc will overwrite the oldest one.

Displaying disc titles

● Press D/Scrl to select the desired text information.

- **For title entered CD**
Play time—⏪: disc title and play time
- **For CD TEXT discs**
Play time—⏪: disc artist name and 🎵 : track title
—⏪: disc artist name and ⏪: disc title
—⏪: disc title and 🎵 : track title
—🎵: track artist name and 🎵 : track title
—🎵: track title and play time
- You can scroll through text data by pressing and holding **D/Scrl**.

Selecting discs from the disc title list

Disc title list lets you see the list of disc titles entered in the multi-CD player and select one of them to play back.

● Use **MULTI-CONTROL** to select the desired disc title.

Turn to change the disc title. Press to play.

- You can also change the disc title by pushing **MULTI-CONTROL** up or down.
- When playing CD TEXT disc, push **MULTI-CONTROL** right to see a list of the tracks

in the selected disc. Push **MULTI-CONTROL** left to return to the disc list.

- If no title is entered for a disc, **NO TITLE** is displayed.
- **NO DISC** is displayed next to the disc number when there is no disc in the magazine.
- You can scroll through text data by pressing and holding **D/Scrl**.
- If you do not operate the list within about 30 seconds, the display automatically returns to the ordinary display. ◻

DVD Player

Basic Operations

You can use this unit to control a DVD player or multi-DVD player, which is sold separately.

For details concerning operation, refer to the DVD player's or multi-DVD player's operation manual. This section provides information on DVD operations with this unit which differs from that described in the DVD player's or multi-DVD player's operation manual.

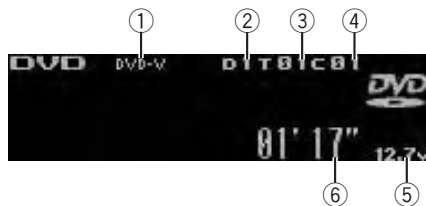

- ① **DVD-V/VCD/CD/MP3/WMA** indicator
Shows the type of disc currently playing.
- ② Disc number indicator
Shows the number of the disc currently playing when using a multi-DVD player.
- ③ Title/Folder number indicator
Shows the title (when playing DVD video) or folder (when playing compressed audio) of the selection currently playing.
- ④ Chapter/track number indicator
Shows the chapter (when playing DVD video) or track (when playing Video CD, CD or compressed audio) currently playing.
- ⑤ Voltage indicator
Shows the battery voltage.

Available accessories

- The level displayed on the voltage indicator may differ from the actual voltage level.

⑥ Play time indicator

● Select a chapter/track

Push **MULTI-CONTROL** left or right.

● Fast forward or reverse

Push and hold **MULTI-CONTROL** left or right.

- When playing compressed audio, there is no sound on fast forward or reverse.

● Select a disc/title

VCD/CD: Push **MULTI-CONTROL** up or down.

DVD-V/MP3/WMA: Push and hold **MULTI-CONTROL** up or down.

● Select a folder

Push **MULTI-CONTROL** up or down.

- You can operate this function only when a DVD player compatible with compressed audio playback is connected to this unit.
- You cannot select a folder that does not have a compressed audio file recorded in it.

Introduction to advanced operations

1 Press MULTI-CONTROL to display the main menu.

2 Use MULTI-CONTROL to select FUNCTION.

Turn to change the menu option. Press to select.

3 Turn MULTI-CONTROL to select the function.

During DVD video or Video CD playback

Play mode (repeat play)—**Pause** (pause)

During CD playback

Play mode (repeat play)—**Random mode**

(random play)—**Scan mode** (scan play)—

Pause (pause)—**ITS play mode** (ITS play)—

ITS memo (ITS input)—**TitleInput "A"** (disc title input)

During compressed audio playback

Play mode (repeat play)—**Random mode**

(random play)—**Scan mode** (scan play)—

Pause (pause)

- To return to the playback display, press **B**.
- If you do not operate functions except for **ITS memo** and **TitleInput "A"** within about 30 seconds, the display is automatically returned to the ordinary display.

Function and operation

Play mode, Random mode, Scan mode,

Pause and **TitleInput "A"** operations are basically the same as that of the built-in CD player. Also, **ITS play mode** and **ITS memo** operations are basically the same as that the multi-CD player.

Function name	Operation
Play mode	Refer to <i>Selecting a repeat play range</i> on page 19. But the repeat play range that you can select is vary depending on the type of disc or system. The repeat play ranges of the DVD player/multi-DVD player are as below: During PBC playback of Video CDs, this function cannot be operated.
	<ul style="list-style-type: none"> Disc repeat – Repeat the current disc Folder repeat – Repeat the current folder Title repeat – Repeat just the current title Chapter repeat – Repeat just the current chapter Track repeat – Repeat the current track
Random mode	Refer to <i>Playing tracks in random order</i> on page 19.
Scan mode	Refer to <i>Scanning folders and tracks</i> on page 20.
Pause	Refer to <i>Pausing playback</i> on page 20.
ITS play mode	Refer to <i>Using ITS playlists</i> on page 60.

ITS memo

Refer to *Using ITS playlists* on page 60.

TitleInput "A"

Refer to *Entering disc titles* on page 20.

**Notes**

- If you select other discs during repeat play, the repeat play range changes to **Disc repeat**.
- When playing back Video CD or CD, if you perform track search or fast forward/reverse during **Track repeat**, the repeat play range changes to **Disc repeat**.
- When playing back compressed audio, if you select another folder during repeat play, the repeat play range changes to **Disc repeat**.
- When playing back compressed audio, if you perform track search or fast forward/reverse during **Track repeat**, the repeat play range changes to **Folder repeat**.
- Multi-DVD player that has ITS functions and disc title functions can also be connected to this unit. In this case, **ITS play mode**, **ITS memo** and disc title input can be controlled.
- The ITS function of a DVD player differs slightly from ITS playback with a multi-CD player. With multi-DVD player, ITS playback applies only to the CD playing. For details, refer to *Using ITS playlists* on page 60. 

TV tuner

Basic Operations

You can use this unit to control a TV tuner, which is sold separately.

For details concerning operation, refer to the TV tuner's operation manual. This section provides information on TV operations with this unit, which differs from that described in the TV tuner's operation manual.



- ① Band indicator
- ② Preset number indicator
- ③ Voltage indicator
Shows the battery voltage.
 - The level displayed on the voltage indicator may differ from the actual voltage level.
- ④ Channel indicator

- **Select a band**

Press **B**.

- **Select a channel (step by step)**

Push **MULTI-CONTROL** left or right.

- **Seek tuning**

Push and hold **MULTI-CONTROL** left or right, and then release.

**Notes**

- Band can be selected from **TV-1** or **TV-2**.
- You can cancel seek tuning by pushing **MULTI-CONTROL** left or right.
- While pushing and holding **MULTI-CONTROL** left or right, you can skip stations. Seek tuning starts as soon as you release **MULTI-CONTROL**.

Storing and recalling broadcast stations

You can easily store up to 12 broadcast stations for later recall.

- 12 stations for each band can be stored in memory.

Available accessories

1 Use MULTI-CONTROL to store the selected station in memory.

Turn to change the preset number. Press and hold to store.

2 Use MULTI-CONTROL to select the desired station.

Turn to change the station. Press to select.

- You can also change the station by pushing **MULTI-CONTROL** up or down.
- If you do not operate the list within about 30 seconds, the display automatically returns to the ordinary display.
- You can also recall stations assigned to preset tuning numbers by pushing **MULTI-CONTROL** up or down during the channel display.

Storing the strongest broadcast stations sequentially

1 Press MULTI-CONTROL to display the main menu.

2 Use MULTI-CONTROL and select FUNCTION to display BSSM.

3 Press MULTI-CONTROL to turn BSSM on.

Searching begins to flash. While **Searching** is flashing, the 12 strongest broadcast stations are stored in order from the lowest channel up. When finished, the preset channel list appears.

- To cancel the storage process, press **MULTI-CONTROL** again.

4 Use MULTI-CONTROL to select the desired station.

Turn to change the station. Press to select.

- You can also change the station by pushing **MULTI-CONTROL** up or down.
- To return to the ordinary display, press **B**.
- If you do not operate the list within about 30 seconds, the display automatically returns to the ordinary display. 

Additional Information

Error messages

When you contact your dealer or your nearest Pioneer Service Center, be sure to have the error message recorded.

Built-in CD Player

Message	Cause	Action
ERROR-11, 12, 17, 30	Dirty disc	Clean disc.
	Scratched disc	Replace disc.
ERROR-10, 11, 12, 15, 17, 30, A0	Electrical or mechanical	Turn the ignition switch OFF and back ON, or switch to a different source, then back to the CD player.
ERROR-15	The inserted disc does not contain any data	Replace disc.
ERROR-22, 23	The CD format cannot be played back	Replace disc.
NO AUDIO	The inserted disc does not contain any files that can be played back	Replace disc.
TRK SKIPPED	The inserted disc contains WMA files that are protected by DRM	Replace disc.
PROTECT	All the files on the inserted disc are secured by DRM	Replace disc.

USB storage device

Message	Cause	Action
NO AUDIO	No songs	Transfer the audio files to the external storage device and connect.
	USB storage device with security enabled is connected	Follow the USB storage device instructions to disable the security.
NO DEVICE	The USB storage device or iPod is not connected to the USB port of this unit.	Connect a compatible USB storage device.

TRK SKIPPED	The connected USB storage device contains WMA files that are protected by Windows Media Center™ DRM 9/10	Play an audio file not protected by Windows Media DRM 9/10.
PROTECT	All the files in the USB storage device are protected by Windows Media DRM 9/10	Transfer audio files not protected by Windows Media DRM 9/10 to the USB storage device and connect.
NOT COMPATIBLE	The USB storage device connected to is not supported by this unit.	Connect a USB storage device that is USB Mass Storage Class compliant.
CHECK USB	The USB connector or USB cable is short-circuited.	Confirm that the USB connector or USB cable is not caught in something or damaged.
	The connected USB storage device consumes more than 500 mA (maximum allowable current).	Disconnect the USB storage device and do not use it. Turn the ignition switch to OFF, then to ACC or ON and then connect the compliant USB storage device.
ERROR-19	Communication failure	Perform one of the following operations. –Turn the ignition switch OFF and back ON. –Disconnect or eject the USB storage device. –Change to a different source. Then, return to the USB source.
ERROR-23	USB storage device is not formatted with FAT16 or FAT32	USB storage device should be formatted with FAT16 or FAT32.

Additional Information

iPod

Message	Cause	Action
ERROR-19	Communication failure	Disconnect the cable from iPod. Once iPod main menu is displayed, connect the cable again. Reset the iPod.
	iPod failure	Disconnect the cable from iPod. Once iPod main menu is displayed, connect the cable again. Reset the iPod.
ERROR-16, 18	Old version of iPod	Update the iPod version.
	iPod failure	Disconnect the cable from iPod. Once iPod main menu is displayed, connect the cable again. Reset the iPod.
ERROR-A1 CHECK USB	iPod is not charged but operates correctly	Check if the connection cable for iPod shorted out (e.g., not caught in metal objects). After checking, turn the ignition switch OFF and back ON or disconnect the iPod and connect again.
NO SONGS	No songs	Transfer the songs to iPod.
STOP	No songs in the current list	Select a list that contains the songs.
NO DEVICE	The USB storage device or iPod is not connected to the USB port of this unit.	Connect a compatible iPod.



Understanding auto TA and EQ error messages

When correct measurement of car interior acoustic characteristics is not possible using the auto TA and EQ, an error message may appear on the display. If an error message appears, refer to the table below to see what the problem is and the suggested method of correcting the problem. After checking, try again.

Message	Cause	Action
ERR:MIC check	Microphone is not connected.	Plug the supplied microphone securely into the jack.
ERR:High Band. ERR: High-Lch. ERR:High-Rch. ERR:Mid Band. ERR:Mid-Lch. ERR:Mid-Rch. ERR:Low Band. ERR: Low-Lch. ERR: Low-Rch. ERR: SUBWOOFER. ERR:SW-Lch. ERR:SW-Rch	The microphone cannot pick up the measuring tone of a speaker.	<ul style="list-style-type: none"> • Confirm that the speakers are connected correctly. • Correct the input level setting of the power amp connected to the speakers. • Set the microphone correctly.
ERR:Outside Noise	The surrounding noise level is too high.	<ul style="list-style-type: none"> • Stop your car in a place that is as quiet as possible, and switch off the engine, air conditioner or heater. • Set the microphone correctly.



Additional Information

Handling guideline of discs and player

- Use only discs featuring either of following two logos.



- Use only conventional, fully circular discs. Do not use shaped discs.



- Use a 12-cm CD. Do not use an 8-cm disc.
- Do not insert anything other than a CD into the CD loading slot.
- Do not use cracked, chipped, warped, or otherwise damaged discs as they may damage the player.
- Unfinalized CD-R/CD-RW disc playback is not possible.
- Do not touch the recorded surface of the discs.
- Store discs in their cases when not in use.
- Avoid leaving discs in excessively hot environments including under direct sunlight.
- Do not attach labels, write on or apply chemicals to the surface of the discs.
- To clean a CD, wipe the disc with a soft cloth outward from the center.
- Condensation may temporarily impair the player's performance. Leave it to adjust to the warmer temperature for about one hour. Also, wipe any dump discs with a soft cloth.
- Playback of discs may not be possible because of disc characteristics, disc format, recorded application, playback environment, storage conditions, and so on.

- Text information may not be correctly displayed depending on the recorded environment.
- Road shocks may interrupt disc playback.
- Read the precautions for discs before using them.

DualDiscs

- DualDiscs are two-sided discs that have a recordable CD for audio on one side and a recordable DVD for video on the other.
- Since the CD side of DualDiscs is not physically compatible with the general CD standard, it may not be possible to play the CD side with this unit.
- Frequent loading and ejecting of a Dual-Disc may result in scratches on the disc. Serious scratches can lead to playback problems on this unit. In some cases, a Dual-Disc may become stuck in the disc loading slot and will not eject. To prevent this, we recommend you refrain from using Dual-Disc with this unit.
- Please refer to the information from the disc manufacturer for more detailed information about DualDiscs.

Handling guideline of USB storage device and this unit

- This unit can play back files in the USB portable audio player/USB memory that is USB Mass Storage Class.
- Optimum performance of this unit may not be obtained depending on the connected USB storage device.
- Do not leave the USB storage device in any place with high temperatures.
- Depending on the kind of USB storage device you use, this unit may not recognize the storage device or file may not be played back properly.
- Operations may vary depending on the kind of a USB storage device.

Additional Information

- You cannot connect a USB storage device to this unit via a USB hub.
- Do not plug anything other than the USB storage device into the USB port.
- Firmly secure the USB storage device when driving. Do not let the USB storage device fall onto the floor, where it may become jammed under the brake or accelerator pedal.
- Partitioned USB storage device is not compatible with this unit.
- Depending on the USB storage device connected to this unit, it may generate noise in the radio. 

Compressed audio compatibility (disc, USB)

WMA

- Compatible format: WMA encoded by Windows Media Player
- File extension: .wma
- Bit rate: 48 kbps to 320 kbps (CBR), 48 kbps to 384 kbps (VBR)
- Sampling frequency: 32 kHz to 48 kHz
- Windows Media Audio Professional, Lossless, Voice: No

MP3

- File extension: .mp3
- Bit rate: 8 kbps to 320 kbps (CBR, VBR)
- Sampling frequency: 16 kHz to 48 kHz (32, 44.1, 48 kHz for emphasis)
- Compatible ID3 tag version: 1.0, 1.1, 2.2, 2.3, 2.4 (ID3 tag Version 2.x is given priority than Version 1.x.)
- M3u playlist: No
- MP3i (MP3 interactive), mp3 PRO: No

AAC

- Compatible format: AAC encoded by iTunes
- File extension: .m4a
- Transmission rate: 16 kbps to 320 kbps (CBR)
- Sampling frequency: 11.025 kHz to 48 kHz
- Apple Lossless: No

WAV

- Compatible format: Linear PCM (LPCM), MS ADPCM
- File extension: .wav
- Quantization bits: 8 and 16 (LPCM), 4 (MS ADPCM)
- Sampling frequency: 16 kHz to 48 kHz (LPCM), 22.05 kHz to 44.1 kHz (MS ADPCM)

Supplemental information of compressed audio (disc, USB)

- There may be a slight delay when starting playback of audio files encoded with image data.
- File extensions must be used properly.
- Only 32 characters from the beginning can be displayed as a file name (including the extension) or a folder name.
- Russian text to be displayed on this unit should be encoded with the following character sets:
 - Unicode (UTF-8, UTF-16)
 - Character sets other than Unicode that are used in Windows environment and are set to Russian in the multi-language setting
- The text information of some audio files may not be correctly displayed. 

Compressed audio files on the disc

- ISO 9660 Level 1 and 2 compliant. Romeo and Joliet file systems are both compatible with this player.
- Multi-session playback is possible.
- Compressed audio files are not compatible with packet write data transfer.
- Regardless of the length of blank section between the songs of original recording, compressed audio discs play with a short pause between songs. 

Additional Information

Compressed audio files in the USB storage device

About USB storage device compatibility, refer to *Specifications* on page 73.

- Copyright protected files cannot be played back.
- There may be a slight delay when starting playback of audio files on a USB storage device with numerous folder hierarchies. 

Example of a hierarchy and playback sequences

 Folder

 Compressed audio file

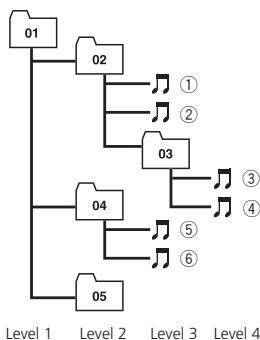

The sequence of audio files on the USB storage device

For USB portable audio players, the sequence is different and depends on the player.

- 01 to 05 represent assigned folder numbers. ① to ⑥ represent the playback sequence. The user cannot assign folder numbers and specify the playback sequence with this unit.
- Playback sequence is the same as recorded sequence in the USB storage device.
- To specify the playback sequence, the following method is recommended.
 - 1 Create the file name including numbers that specify the playback sequence (e.g., 001xxx.mp3 and 099yyy.mp3).
 - 2 Put those files into a folder.
 - 3 Record the folder containing files into the USB storage device.

However, depending on the system environment, you cannot specify the playback sequence.

- Up to 15 000 files in a USB storage device can be played back.
- Up to 500 folders in a USB storage device can be played back.
- Up to eight tiers directory in a USB storage device can be played back. 

The sequence of audio files on the disc

- This unit assigns folder numbers. The user cannot assign folder numbers.
- Folder selection sequence or other operation may be altered depending on the encoding or writing software.
- For practical use, the folder hierarchy should have as few tiers as possible.
- Up to 999 files on a disc can be played back.
- Up to 99 folders on a disc can be played back.

iPod

iPod compatibility

- This unit supports only the following iPod models. Supported iPod software versions are shown below. Older versions of iPod software may not be supported.
 - iPod nano first generation (software version 1.3.1)
 - iPod nano second generation (software version 1.1.3)
 - iPod nano third generation (software version 1.1.2)
 - iPod nano fourth generation (software version 1.0.3)

Additional Information

- iPod fifth generation (software version 1.3.0)
- iPod classic (software version 1.1.2)
- iPod touch (software version 2.0)
- iPhone (software version 2.0)
- iPhone 3G (software version 2.0)
- Depending on the generation or version of the iPod, some functions can not be operated.
- Operations may vary depending on the software version of iPod.
- When using an iPod, iPod Dock Connector to USB Cable is required.
- Pioneer CD-IU50 interface cable is also available. For details, consult your dealer.
- This unit can control previous generations iPod models with a Pioneer iPod adapter (e.g. CD-IB100II).
For details concerning operation with the iPod adapter, refer to *Playing songs on iPod* on page 47.

About handling the iPod

- Do not leave the iPod in direct sunlight for extended amounts of time. Extended exposure to direct sunlight can result in iPod malfunction due to the resulting high temperature.
- Do not leave the iPod in a high temperature.
- Connect directly the dock connector cable to the iPod so that this unit works properly.
- Firmly secure the iPod when driving. Do not let the iPod fall onto the floor, where it may become jammed under the brake or accelerator pedal.
- For details, refer to the iPod's manuals.

About iPod settings

- You cannot operate the iPod Equalizer on Pioneer products. We recommend that you set the iPod Equalizer to off, before connecting to this unit.
- You cannot set Repeat to off on the iPod when using this unit. Even if you set Repeat

to off on the iPod, Repeat is automatically changed to All when connecting the iPod to this unit. ■

Copyright and trademark notice

WMA



Windows Media and the Windows logo are trademarks or registered trademarks of Microsoft Corporation in the United States and/or other countries.

This product includes technology owned by Microsoft Corporation and cannot be used or distributed without a license from Microsoft Licensing, Inc.

MP3

Supply of this product only conveys a license for private, non-commercial use and does not convey a license nor imply any right to use this product in any commercial (i.e. revenue-generating) real time broadcasting (terrestrial, satellite, cable and/or any other media), broadcasting/streaming via internet, intranets and/or other networks or in other electronic content distribution systems, such as pay-audio or audio-on-demand applications. An independent license for such use is required. For details, please visit <http://www.mp3licensing.com>.

iTunes

Apple and iTunes are trademarks of Apple Inc., registered in the U.S. and other countries.

Additional Information

iPod



iPod is a trademark of Apple Inc., registered in the U.S. and other countries.

"Made for iPod" means that an electronic accessory has been designed to connect specifically to iPod and has been certified by the developer to meet Apple performance standards.

Apple is not responsible for the operation of this device or its compliance with safety and regulatory standards.

iPhone



iPhone is a trademark of Apple Inc.

"Works with iPhone" means that an electronic accessory has been designed to connect specifically to iPhone and has been certified by the developer to meet Apple performance standards.

Apple is not responsible for the operation of this device or its compliance with safety and regulatory standards. □

Additional Information

Specifications

General

Power source	14.4 V DC (10.8 V to 15.1 V allowable)
Grounding system	Negative type
Max. current consumption	2.0 A
Dimensions (W × H × D): DIN	
Chassis	178 mm × 50 mm × 164 mm
Nose	188 mm × 58 mm × 18 mm
D	
Chassis	178 mm × 50 mm × 164 mm
Nose	170 mm × 45 mm × 18 mm
Weight	1.6 kg

Audio/DSP

Preout max output level	5.0 V
Loudness contour	+10 dB (100 Hz), +6.5 dB (10 kHz) (volume: -30 dB)
Equalizer (Left/Right independent 31-Band Graphic Equalizer):	
Frequency	20/25/31.5/40/50/63/80/100/125/160/200/250/315/400/500/630/800/1k/1.25k/1.6k/2k/2.5k/3.15k/4k/5k/6.3k/8k/10k/12.5k/16k/20k Hz
Equalization range	±12 dB (0.5 dB step)
Time alignment	0 cm to 394.24 cm (0.77 cm/step), 0 inch to 155.392 inch (0.3035 inch/step)
Network (Left/Right independent):	
High:	

LPF

Frequency	5k/6.3k/8k/10k/12.5k/16k/20k Hz
Slope	PASS, -6/-12/-18/-24/-30/-36 dB/oct
Gain	0 dB to -24 dB/Mute (1 dB step)
Phase	Normal/Reverse

HPF

Frequency	800/1k/1.25k/1.6k/2k/2.5k/3.15k/4k/5k/6.3k/8k/10k/12.5k/16k Hz
Slope	-6/-12/-18/-24/-30/-36 dB/oct
Gain	0 dB to -24 dB/Mute (1 dB step)
Phase	Normal/Reverse

Mid:

HPF/LPF

Frequency (LPF) ...	25/31.5/40/50/63/80/100/125/160/200/250/315/400/500/630/800/1k/1.25k/1.6k/2k/2.5k/3.15k/4k/5k/6.3k/8k/10k/12.5k/16k/20k Hz
---------------------	--

Frequency (HPF)

.....	20/25/31.5/40/50/63/80/100/125/160/200/250/315/400/500/630/800/1k/1.25k/1.6k/2k/2.5k/3.15k/4k/5k/6.3k/8k/10k/12.5k/16k Hz
-------	---

Slope (LPF)

Slope (HPF)

Gain

Phase

Low:

HPF/LPF

Frequency (LPF) ...	25/31.5/40/50/63/80/100/125/160/200/250/315/400/500/630/800/1k/1.25k/1.6k/2k/2.5k/3.15k/4k/5k/6.3k/8k/10k/12.5k/16k/20k Hz
---------------------	--

Frequency (HPF)

.....	20/25/31.5/40/50/63/80/100/125/160/200/250/315/400/500/630/800/1k/1.25k/1.6k/2k/2.5k/3.15k/4k/5k/6.3k/8k/10k/12.5k/16k Hz
-------	---

Slope (LPF)

Slope (HPF)

Gain

Phase

SW:

HPF/LPF

Frequency (LPF) ...	25/31.5/40/50/63/80/100/125/160/200/250/315/400/500/630/800/1k/1.25k/1.6k/2k/2.5k/3.15k/4k/5k/6.3k/8k/10k/12.5k/16k/20k Hz
---------------------	--

Frequency (HPF)

.....	20/25/31.5/40/50/63/80/100/125/160/200/250/315/400/500/630/800/1k/1.25k/1.6k/2k/2.5k/3.15k/4k/5k/6.3k/8k/10k/12.5k/16k Hz
-------	---

Additional Information

Slope (LPF)	PASS, -6/-12/-18/-24/-30/ -36 dB/oct
Slope (HPF)	PASS, -6/-12/-18/-24/-30/ -36 dB/oct
Gain	+6 dB to -24 dB/Mute (1 dB step)
Phase	Normal/Reverse

CD player

System	Compact disc audio system
Usable discs	Compact disc
Signal-to-noise ratio	115 dB (1 kHz) (IEC-A net- work)
Number of channels	2 (stereo)
MP3 decoding format	MPEG-1 & 2 Audio Layer 3
WMA decoding format	Ver. 7, 7.1, 8, 9, 10, 11 (2ch audio) (Windows Media Player)
AAC decoding format	MPEG-4 AAC (iTunes en- coded only) (.m4a) (Ver. 7.7 and earlier)
WAV signal format	Linear PCM & MS ADPCM (Non-compressed)

USB

USB standard specification	USB 2.0 full speed
Maximum current supply	500 mA
Minimum memory capacity	256 MB
USB Class	MSC (Mass Storage Class)
File system	FAT16, FAT32
MP3 decoding format	MPEG-1 & 2 Audio Layer 3
WMA decoding format	Ver. 7, 7.1, 8, 9, 10, 11 (2ch audio) (Windows Media Player)
AAC decoding format	MPEG-4 AAC (iTunes en- coded only) (.m4a) (Ver. 7.7 and earlier)
WAV signal format	Linear PCM & MS ADPCM (Non-compressed)

FM tuner

Frequency range	87.5 MHz to 108.0 MHz
Usable sensitivity	9 dBf (0.8 μ V/75 Ω , mono, S/N: 30 dB)
Signal-to-noise ratio	72 dB (IEC-A network)

MW tuner

Frequency range	531 kHz to 1 602 kHz (9 kHz)
Usable sensitivity	25 μ V (S/N: 20 dB)
Signal-to-noise ratio	62 dB (IEC-A network)

LW tuner

Frequency range	153 kHz to 281 kHz
Usable sensitivity	28 μ V (S/N: 20 dB)
Signal-to-noise ratio	62 dB (IEC-A network)



Note

Specifications and the design are subject to mod-
ifications without notice due to improvements. 

<http://www.pioneer.eu>

Visit **www.pioneer.co.uk** (or **www.pioneer.eu**) to register your product.

Visite **www.pioneer.es** (o **www.pioneer.eu**) para registrar su producto.

Zum Registrieren Ihres Produktes besuchen Sie bitte **www.pioneer.de** (oder **www.pioneer.eu**) .

Visitez **www.pioneer.fr** (ou **www.pioneer.eu**) pour enregistrer votre appareil.

Si prega di visitare il sito **www.pioneer.it** (o **www.pioneer.eu**) per registrare il prodotto.

Bezoek **www.pioneer.nl** (of **www.pioneer.eu**) om uw product te registreren.

Посетите **www.pioneer-rus.ru** (или **www.pioneer.eu**) для регистрации приобретенного Вами изделия.

PIONEER CORPORATION

4-1, MEGURO 1-CHOME, MEGURO-KU
TOKYO 153-8654, JAPAN

PIONEER ELECTRONICS (USA) INC.

P.O. Box 1540, Long Beach, California 90801-1540, U.S.A.
TEL: (800) 421-1404

PIONEER EUROPE NV

Haven 1087, Keetberglaan 1, B-9120 Melsele, Belgium/Belgique
TEL: (0) 3/570.05.11

PIONEER ELECTRONICS ASIACENTRE PTE. LTD.

253 Alexandra Road, #04-01, Singapore 159936
TEL: 65-6472-7555

PIONEER ELECTRONICS AUSTRALIA PTY. LTD.

178-184 Boundary Road, Braeside, Victoria 3195, Australia
TEL: (03) 9586-6300

PIONEER ELECTRONICS OF CANADA, INC.

300 Allstate Parkway, Markham, Ontario L3R 0P2, Canada
TEL: 1-877-283-5901
TEL: 905-479-4411

PIONEER ELECTRONICS DE MEXICO, S.A. de C.V.

Bldv.Manuel Avila Camacho 138 10 piso
Col.Lomas de Chapultepec, Mexico, D.F. 11000
TEL: 55-9178-4270

先鋒股份有限公司

總公司：台北市中山北路二段44號13樓
電話：(02) 2521-3588

先鋒電子（香港）有限公司

香港九龍尖沙嘴海港城世界商業中心
9樓901-6室
電話：(0852) 2848-6488

Published by Pioneer Corporation.

Copyright © 2009 by Pioneer Corporation.
All rights reserved.

Printed in Japan

<CRB3063-A> EW

<KSNZF> <09D00000>